



A Comprehensive guide for installation

T-ERA
PCC (TS)





250A

Swift Elite

SECURE

2344

R PHASE

Y PHASE

B PHASE

OFF

ON



Thank you for choosing L&T Electrical & Automation (E&A) as your supplier of Low Voltage Switchgear and giving us the opportunity to serve you. Please read this manual carefully for proper installation, safe, easy and efficient operation.

Only authorized and qualified personnel should be allowed to work on the switchgear. An authorized and qualified operator is a person having detailed information about installation and commissioning of switchgear or specially trained for the maintenance of the switchgear and fully aware of the hazards caused by unsafe operation. An operator should also have basic knowledge of First Aid.

The information herein is general for all specifications, part of which may not be applicable for specific applications or variants. Refer the following 'as built' documents for any particular installation:

- Reference list of drawings (RLD)
- Single line drawings
- General Arrangement (GA) drawings
- Master bill of materials (MBOM)
- Scheme drawings

In case of any conflict between this manual and drawings available with you, the drawings shall take precedence.

For additional information or clarification please send your queries to AtYourService@Lntebg.com for quick resolution.

All our switchgear undergo rigorous testing and quality checks at our factory. However, we recommend verification and testing at site, especially after storage.

Following symbols have been used in this manual to indicate varying levels of danger:

 **Warning-Highly dangerous- can cause death or serious injury**

 **Caution-Dangerous- can cause injuries or damage the switchgear.**

1	INTRODUCTION	1
2	CONSTRUCTION	2
	• TECHNICAL DATA	4
	• PANEL CONFIGURATIONS	6
	• BUSBARS AND DROPPERS	10
	• AUXILIARY BUSBARS	11
3	HANDLING & TRANSPORTATION	12
	• RECEIVING	13
	• HANDLING	13
4	STORAGE	16
5	GENERAL SAFETY	18
6	INSTALLATION	20
	• TYPICAL ARRANGEMENTS	21
	• TOOLS	22
	• SITE PREPARATION	22
	• ERECTION	22
	• FLOOR PREPARATION & PANEL MOUNTING	22
	• CONNECTION OF TRANSPORT UNITS & BUSBARS	24
	• CONNECTION OF EARTHBARS	26
	- PCC (TS) - PCC (TS)	26
	- PCC (TS) - MCC (TX)	26
	• POWER CABLE	27
	• CONTROL CABLES	29
	• INTERPANEL WIRING	29

•	INSTALLATION OF LOOSE MATERIAL	30
-	METERING AND CONTROL DEVICES	30
-	ACB	30
-	CONTROL TRANSFORMERS	32
•	INSTALLING AN EXTENSION PANEL	33
7	SITE TESTING	35
•	TESTING SWITCHBOARDS	36
•	TESTING CURRENT TRANSFORMERS	36
•	TESTING POTENTIAL TRANSFORMERS	36
•	TESTING METERS AND TRANSDUCERS	36
•	TESTING RELAYS	37
•	TESTING CONTROL CIRCUITS	37
8	PRE-ENERGIZING CHECKS	39
•	COMMISSIONING	41
•	OPERATION	43
•	MAINTENANCE	47
-	PRECAUTIONS	48
-	ROUTINE CHECKS	48
-	ACB MAINTENANCE	49
-	REMOVAL OF ACB	50
-	REMOVAL OF DOORS	50
9	TROUBLE SHOOTING	51
10	RECOMMENDATIONS	54
11	LIST OF FIGURES	55
12	LIST OF TABLES	55



12F

13F

14F

LT SWGR PANEL



IMPORTANT NOTE

Only the Specific written Technical Instructions supplied by E&A must be used. Our products must only be commissioned, operated, serviced, repaired or decommissioned in accounts with Technical Instructions which have been supplied by the manufacturer. Non Compliance with this instruction may result in serious damage to the product and its associated items, as well as health hazard or mortal danger.

WARRANTY

Our products are subjected to factory inspection and testing according to the applicable standards and provisions.

The correct function and the service life of the switchgear are influenced greatly by compliance with the installation, commissioning and operating conditions stipulated in this manual.

Non-compliance with these provisions may compromise warranty claims.

Any local provision which does not contradict the specifications of this document, especially as regards safety for personnel and buildings, must be complied with.

E&A cannot be held liable for the possible consequences of:

- Non-compliance with the provisions contained in this manual, which refer to international regulations.
- Non-compliance with the instructions of the suppliers of cables and connecting accessories as regards application and installation.
- Any aggressive climate conditions (humidity, pollution etc.) prevailing in the immediate environment of switchgear not suitable to this effect or not protected accordingly.
- This manual does not contain any instructions regarding the mechanical lock-outs to be performed. The work described is performed on de-energized (on installation) or mechanically locked - out (decommissioned) switchgear.

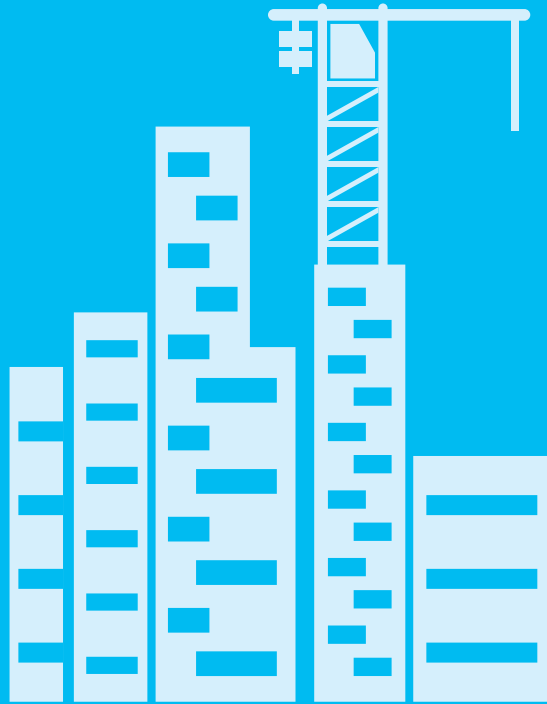

CONSTRUCTION

CONSTRUCTION

1. Power Control Centre type TS is a free-standing and floor mounting switchboard suitable for indoor installation.
2. The frames are of bolted construction with welded base and top.
3. Each vertical panel is divided into distinct zones for busbars, droppers, auxiliary busbars, unit compartment, power cabling and control terminals Figure 2.
4. The unit compartments houses main equipment like Air Circuit Breakers, Fuse Switches, Moulded Case Circuit Breakers and associated auxiliary equipment.
5. For optimum utilization of panel space, compartment have variable heights with a minimum of 220 mm.
6. Up to two tiers of ACB can be mounted in TS panel.
7. Compartment doors are provided with twin-action door fasteners (Cam Lock). While closing, the fastener engages with the frame in the first quarter turn, and in the second quarter turn, it pulls the door towards the frame. This ensures compression of gasket between door and frame. The fasteners are operated by special key.
8. The rear doors are hinged and provided with twin action door-fasteners.

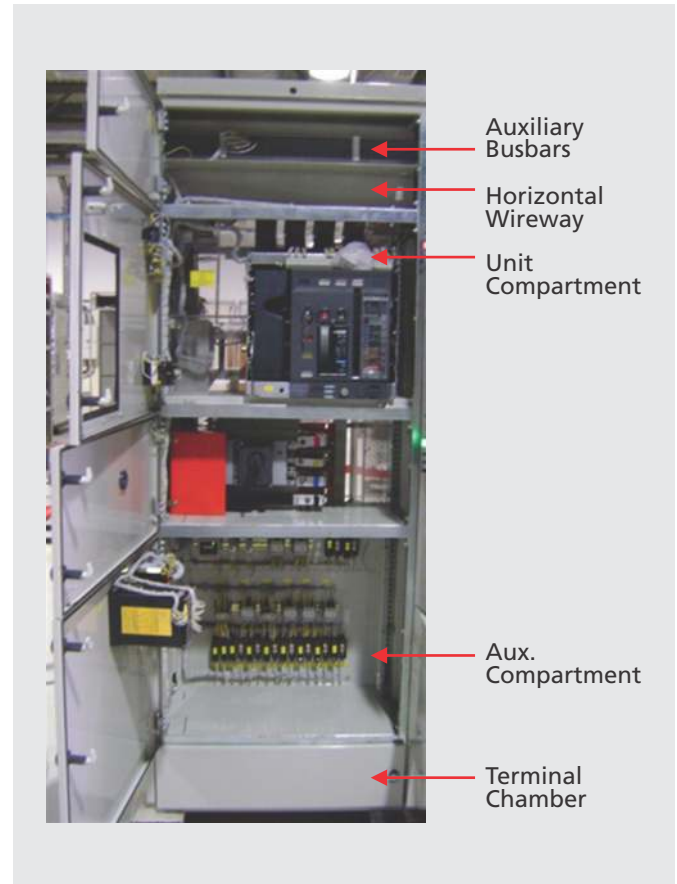

Figure 2 - Door Open view



Figure 1 - Typical PCC panel



E&A's TS range of Low Voltage Power Control Centers comply with IEC 61439-Part1 & 2. TS is designed to enhance safety of the users. Its modular construction facilitates logistics, installation, commissioning and maintenance.

Designation		Power Control Centre (PCC)	Type TS
Standards and specifications		Power Switchgear and Controlgear (PSC) Assemblies	IEC 61439 - 2, BS EN 61439 - 2
		Testing under conditions of arcing due to internal faults	IEC 61641
Insulation characteristics		Clearance	> 20 mm
		Creepage distances	> 20 mm
		Overvoltage category	II / III / IV
		Pollution degree	3
		Field condition	Inhomogeneous (non-uniform)
Electrical characteristics	Voltage ratings	Rated operational voltage (U_e)	up to 690 V
		Rated insulation voltage (U_i)	1000 V
		Rated impulse withstand voltage (U_{imp})	6 / 8 / 12 kV
		Rated frequency (f_n)	50 / 60 Hz

Table No. 1

To increase cabling area, add-on-chambers (AOCs) with a depth of 300 mm & 400 mm are provided on the rear side.

Electrical characteristics	Current ratings	Main Horizontal busbars:	
		Rated current (I_{nA})	up to 6300 A
		Rated peak withstand current (I_{pk})	up to 220 kA
		Rated short-time withstand current (I_{cw})	up to 100 kA, 1s
			up to 65 kA, 3s
		Vertical Distribution busbars for PCC:	
		Rated current (I_{nA})	up to 2000 A
		Rated peak withstand current (I_{pk})	up to 220 kA
		Rated short-time withstand current (I_{cw})	up to 100 kA, 1s
			up to 65 kA, 3s
Internal Arc fault conditions	Rated conditional short-circuit current (I_{cc})	up to 100 kA, Fr3 -2 tier -100 kA arrangement is available	
	Permissible conditional short-circuit current	up to 100 kA	
	Duration	500 ms	
	Acceptance Criteria as per IEC 61641	1 to 7	
Mechanical characteristics	Degree of Protection	In accordance with IEC 60529:	
		External	IP 30 / IP 40 / IP 42 / IP 54
		Internal	IP 2X / IP XXB / IP 4X / IP XXD
	Mechanical Impact	as per IEC 62262	IK 08 / IK 09 / IK 10
	Forms of Separation	as per IEC 61439 - 2	Form 1 to Form 4
		as per BS EN 61439 - 2	upto Form 4, Type 6
	Dimensions	Height (mm)	2200, 2400
		Width (mm)	700, 900, 1000 (PCC)
		Depth (mm)	600, 1000, 1100 (PCC)
	Surface Treatment	Structure	Alu-zinc / powder coated / painted
		Internal Components	Alu-zinc / powder coated / painted
		External Components	powder coated / painted
	Resistance to Corrosion	Damp heat cycling test	IEC 60068-2-30
		Salt mist test	IEC 60068-2-11
	Plastic components	Flame retardant, self-extinguishing, Halogen-free	IEC 60695-2-10, IEC 60695-2-11

Table No. 1

PANEL CONFIGURATION

(Depth = 600mm)

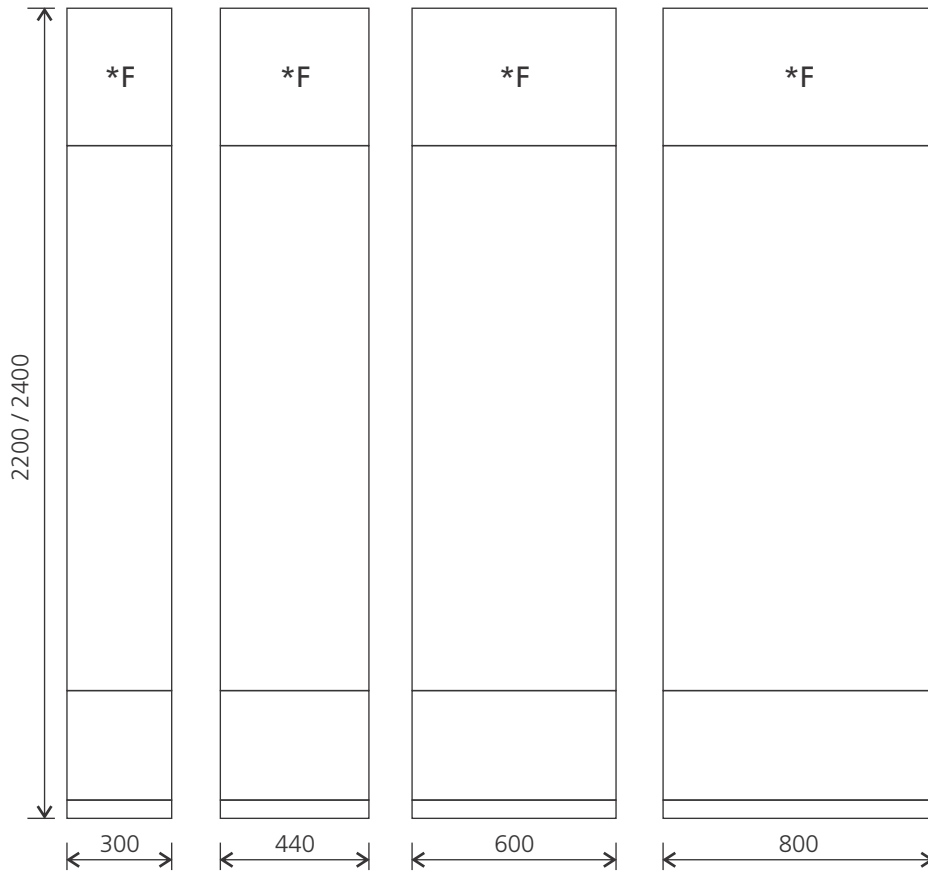

* 1000mm width is also available.

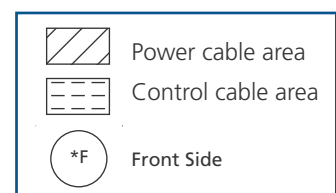
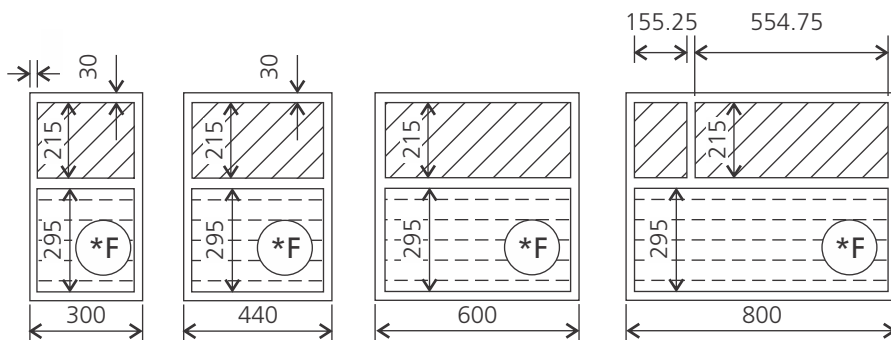

*Dimensions do not include doors

(All dimensions are in mm)

PANEL CONFIGURATION

(Depth = 1000mm)

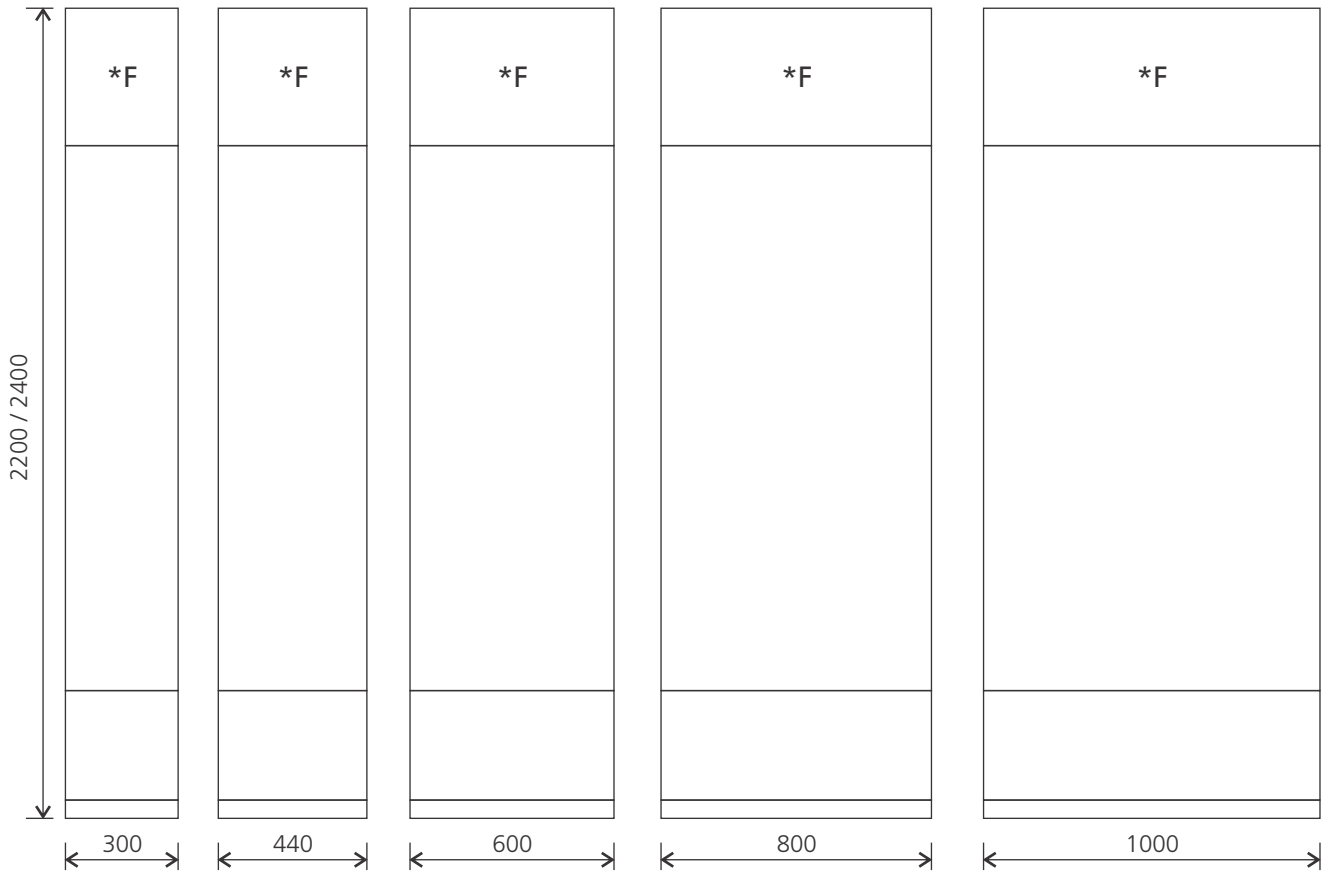

* 700mm & 1200mm width panel is available for 1000/1100/1260D.

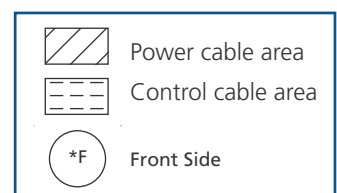
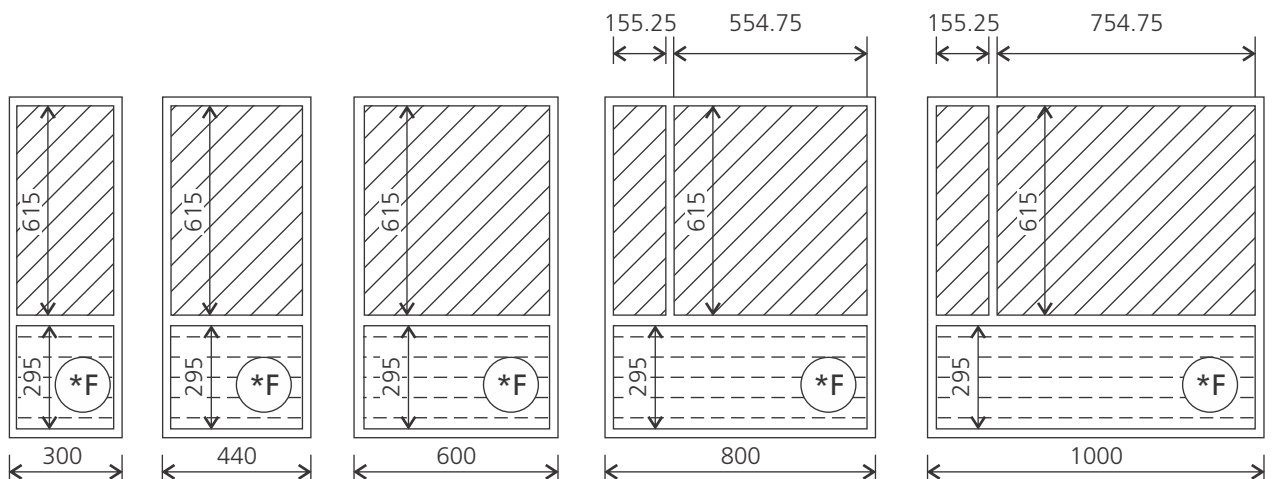

*Dimensions do not include doors

(All dimensions are in mm)

PANEL CONFIGURATION

(Depth = 1100mm)

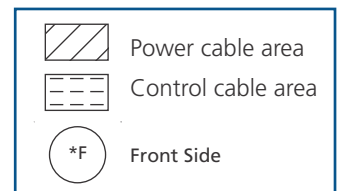
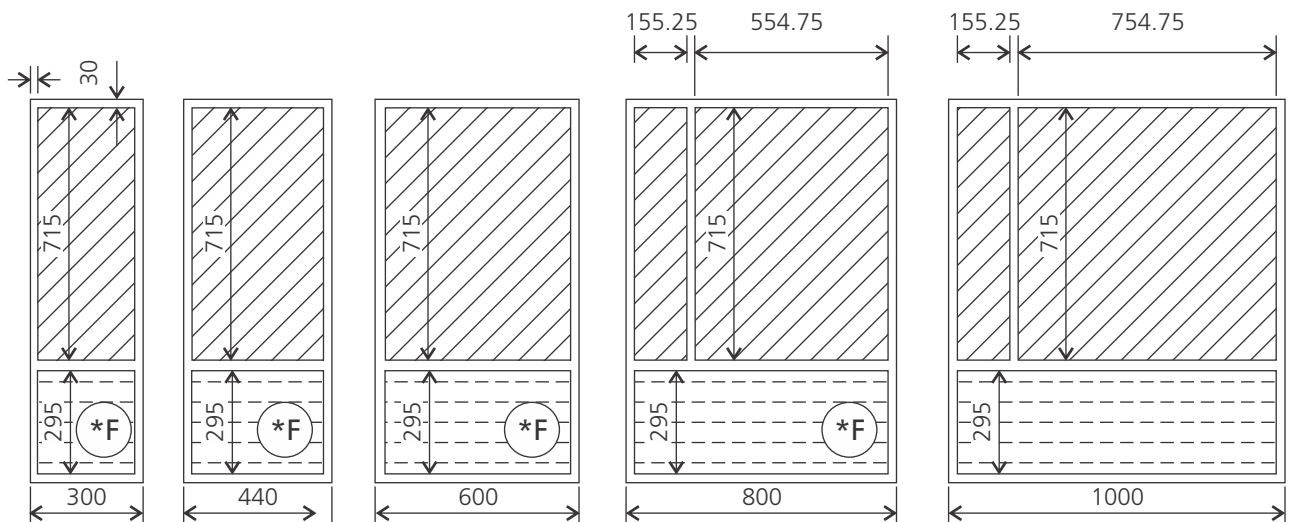
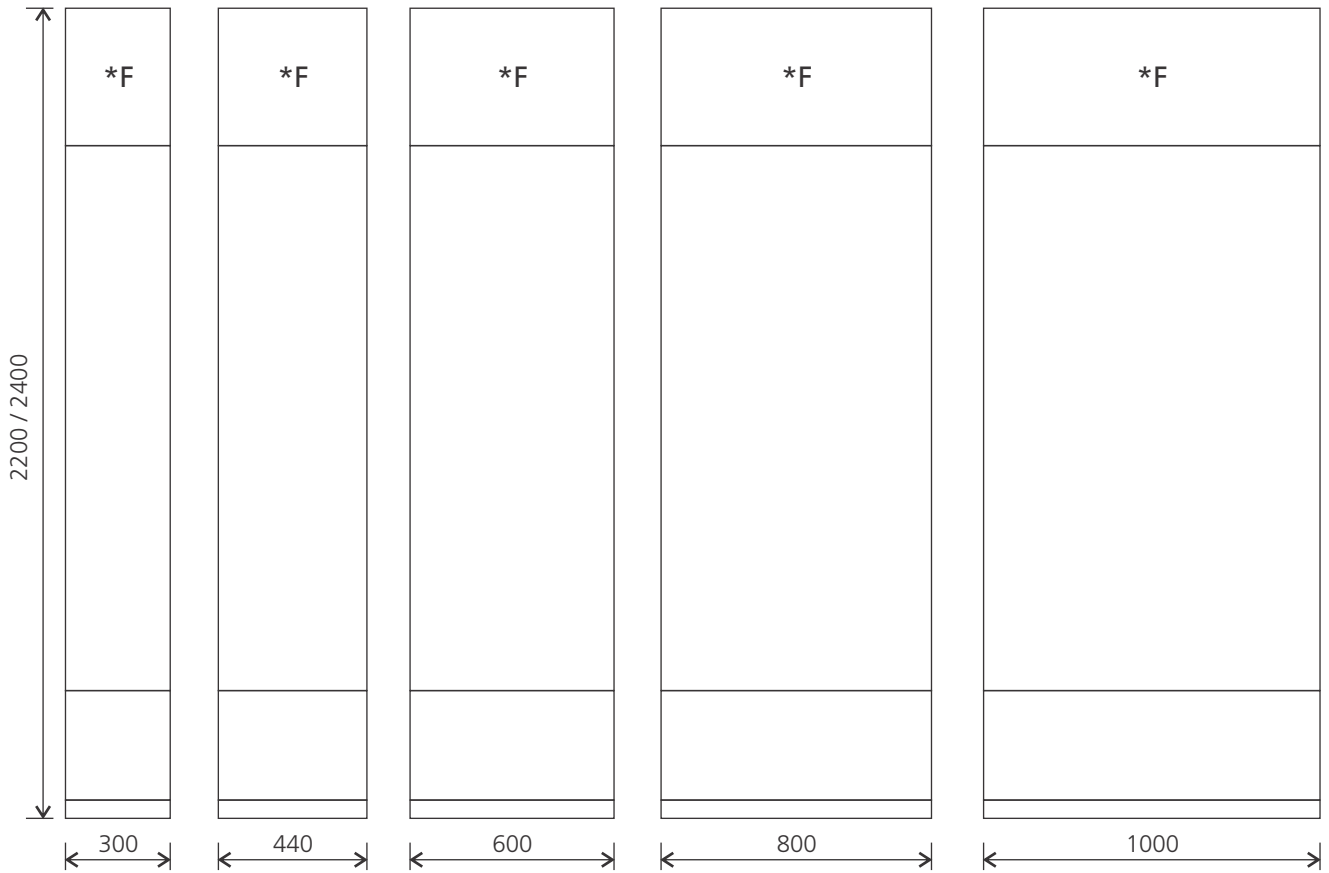

*Dimensions do not include doors

(All dimensions are in mm)

PANEL CONFIGURATION

(Depth = 1260mm)

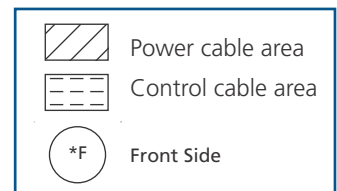
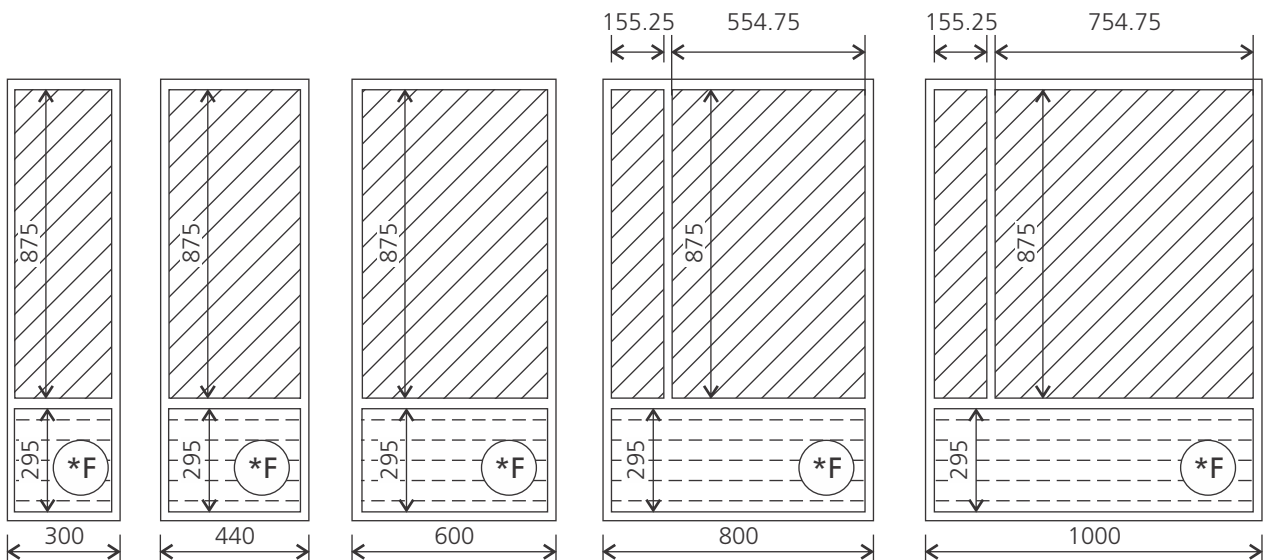
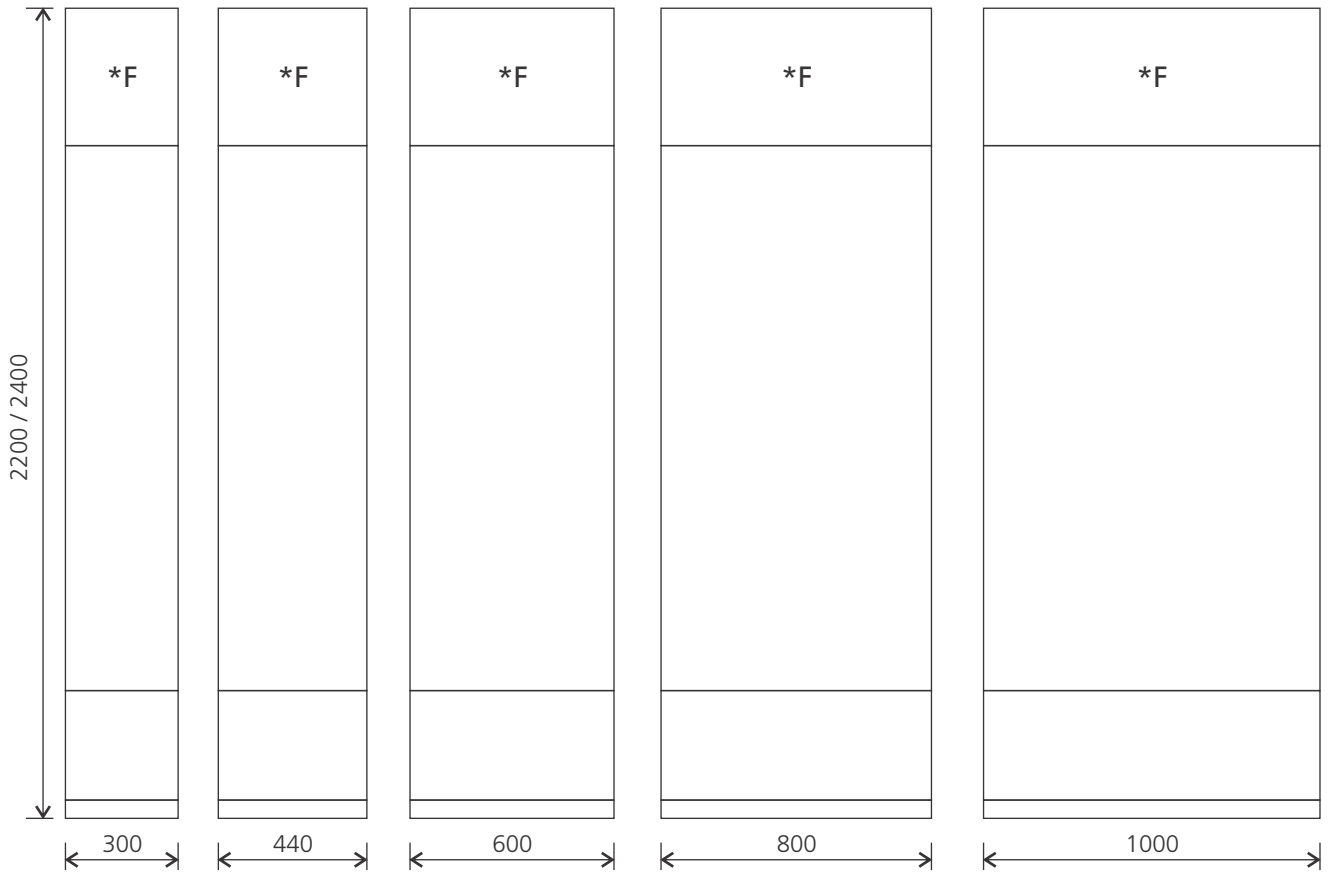

*Dimensions do not include doors

(All dimensions are in mm)

BUSBARS AND DROPPERS

1. Bus-bars are arranged in a Double deck Figure 3. They are available in two variations depending on the rating / busbar material (Aluminum or Copper), - Double deck non-interleaved (DDNIL) arrangement – with phase sequence of B-Y R-N -Double deck interleaved (DDIL) arrangement with phase sequence of B-Y-R-B-Y-R-N with 50% neutral (B-Y-R-B-Y-R-N-N in 100% neutral).
2. In case of DDIL arrangement the busbars are interleaved. The links connecting ACB to busbars or droppers are connected to both packets of busbars and droppers. To facilitate cable / duct termination, cable / duct links are not interleaved. They are stacked together for each phase.



Figure 3 - Double Deck arrangement of busbars

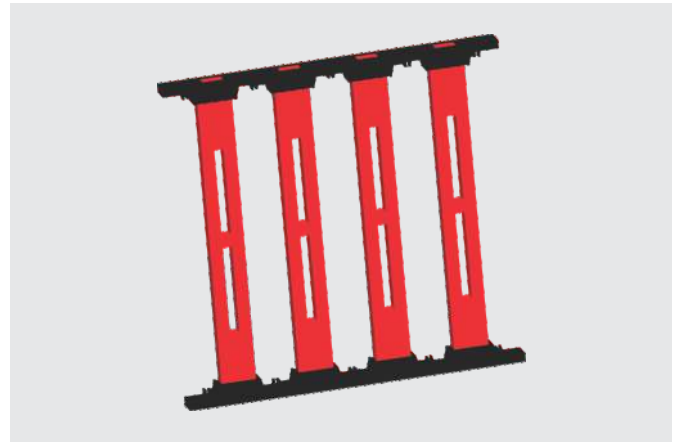

Figure 4 - Busbar Supports

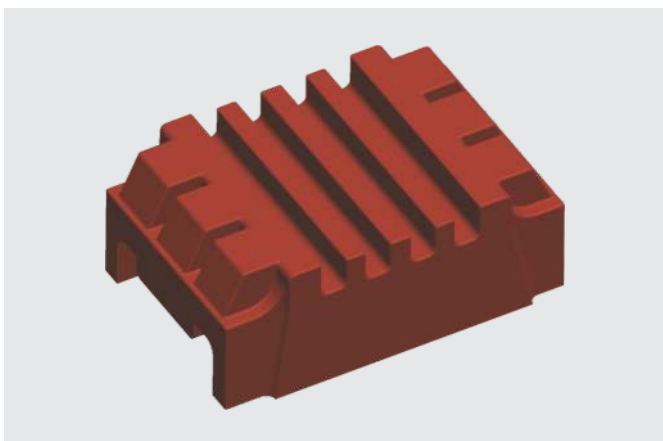
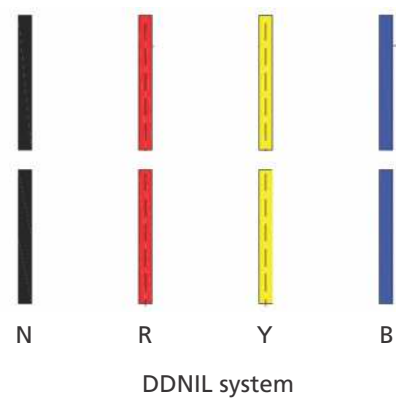
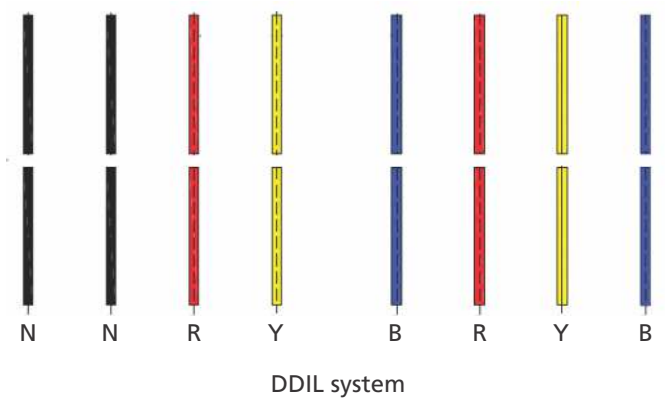

Figure 5 - Four links support

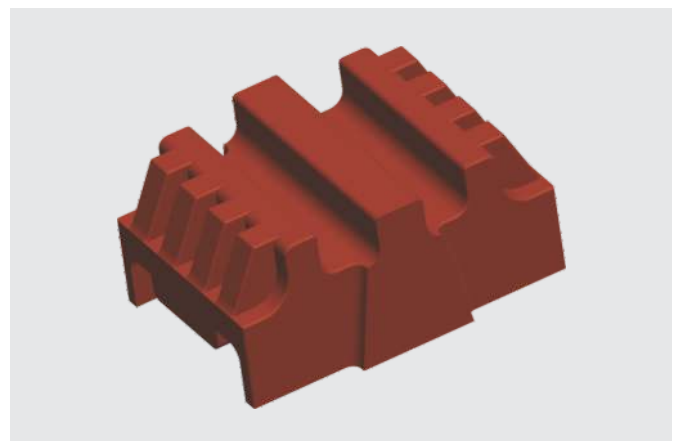

Figure 6 - Two links support

AUXILIARY BUSBARS

Auxiliary busbars are located in the top front chamber of the panel and segregated from main busbars by a metallic partition.

A horizontal wireway is provided immediately below the auxiliary busbar for interpanel wiring. Shipping section terminals if required are mounted in the horizontal wireway Figure 7.

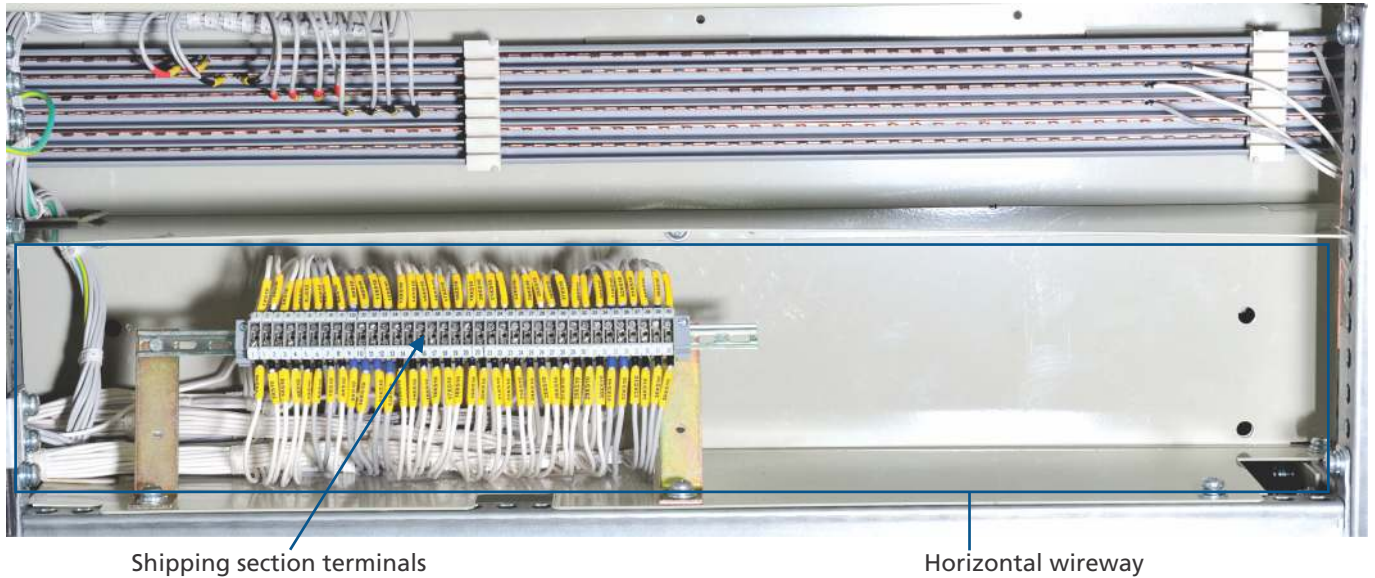

Figure 7 - Aux bus chamber

Up to 12 Auxiliary busbars of 63 A rating can be provided. The Auxiliary busbars are mounted in Nylon Housing to provide segregation and prevent accidental contact.

Block	Sr. No.	Description
	1	Space Heater - Ph
	2	Space Heater - N
1 st block	3	240 / 110 AC V Aux supply - Ph / Clean Earth Bus
	4	240 / 110 AC V Aux supply - N
	5	110 V DC Aux Bus supply - +ve
	6	110 V DC Aux Bus supply - -ve
	7	Annunciation Test Bus
	8	Annunciation Accept Bus
2 nd block	9	Annunciation Reset Bus
	10	Annunciation Alarm Bus
	11	Clean Earth Bus
	12	Configurable
Wire Way		

Table No. 2

* The above table is indicative and can be configured based on actual requirements.



HANDLING AND TRANSPORTATION

Receiving:

On receipt of the PCCs at site:

- Verify the following details on packing case Figure 8 :
 - Item no.:
 - Description of material:
 - Package No.:
 - Gross weight:
 - Net weight:
 - Dimensions:
 - Volumes:
 - Storage of goods:
 - Special instruction:

- Verify the quantity of TUs & loose material as per the packing list.

- If the packing case is damaged, open the cases and inspect the PCCs. Report any damage or loss of components to the transport/carrier and lodge a claim with the insurance agency or inform your nearest E&A office.



Figure 8 - Packing case Details

Handling:

TUs can be handled either by fork-lift or overhead cranes in an upright position depending on where they have to be placed. Care should be taken to see that the TUs don't topple during transportation.

- Avoid tilting of TUs (Panels).
- While transporting the panel using a forklift, ensure that the distance between the legs of the forklift and ground is at least 12 cm.
- Limit the speed of the forklift to 10 kmph.
- Use both legs of the forklift.

If switchgear are to be installed at higher elevations, shift them from the unloading spot through the opening planned in the building for this purpose. This should be one with all safety precautions and strict supervision by trained personnel.



Figure 9 - Positioning of TU on truck



In case of handling by lifting crane,

- Suspend ropes from the hook and pass them under the wooden pallet at the bottom of the TU.
- Center of gravity indicators and chain marks are provided on the TU as shown in Figure 11.
- Use PP (Poly-propylene) ropes of minimum 1" diameter for this purpose. Choose the diameter of the rope according to the weight of the TU which is mentioned in GA your drawing.
- Verify that the route from the unloading spot to the erection spot has free access.
- Unload the TUs after reaching the unloading spot.



Figure 11 - Chain marks on packed TUs

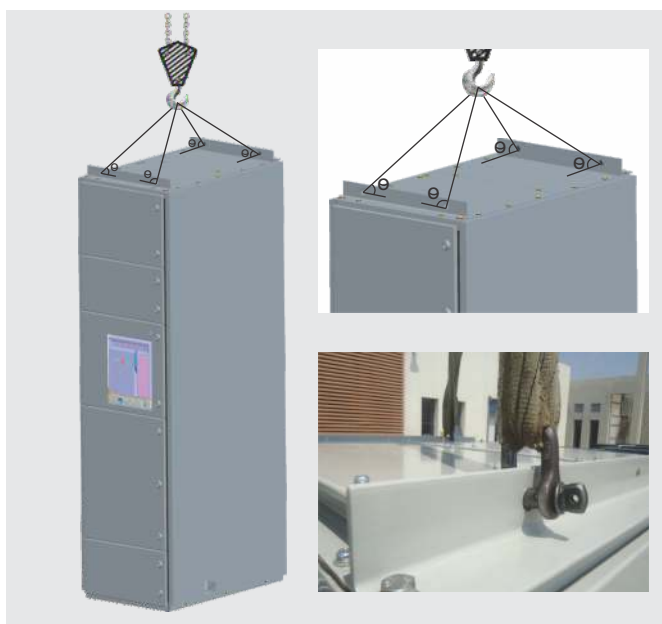

Figure 10 - Lifting angles

! While unloading a TU, ensure that the remaining TUs are placed securely on the truck and are not in danger of toppling over.

If rollers are used for placing the sections on the foundation, retain the base plank to avoid damage to the baseframe.

Ensure that:

- The load of the TU is equally distributed by using all the lifting angle holes.
- The sling of the crane is in good condition.
- The TU does not tilt or topple during transit.

! We recommend handling and shifting panels in packed condition only.

! DO NOT MOVE THE PANEL BY INSERTING A CROWBAR BELOW THE BASE FRAME. This may cause damage to the base frame.

- In case the TU is unpacked before reaching the site, use the lifting channel provided at the top of the panel for easy transportation Figure 9 & Figure 10 .

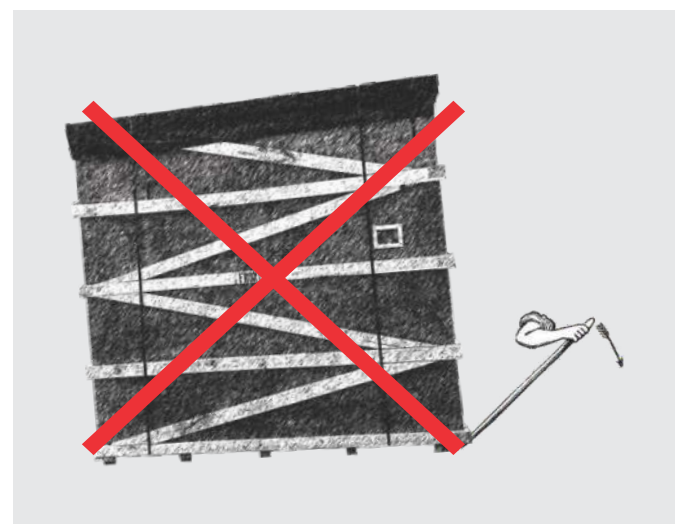

To facilitate transportation and handling, the Power Control Centre (PCC) TS is split into multiple sections/ transport units (TUs). Each section is wrapped with a HDPE (High Density Polyethylene) cover and packed in a wooden case. To arrive at the approximate overall dimensions of the packing cases, add 300 mm to the dimensions of the respective section.

List of equipments and special tools for site erection and assembly

- Crane and truck for equipment shifting.
- Slings and ropes - As per requirement.
- Rolling pipes - 10 Nos.
- Channels - 10 m.
- Crowbars - 4 Nos.
- Welding machines - 1 No.
- Spanner sets - 1 Set.

(Ring & Open spanner size 13mm, 17mm, 19mm, and 24mm. Box or pipe spanner 13mm.)

 For safe handling lifting angle (θ) should be greater than 45° Figure 9 & Figure 10.





STORAGE

STORAGE

If the PCC is to be commissioned at a later date, the following precautions should be taken.

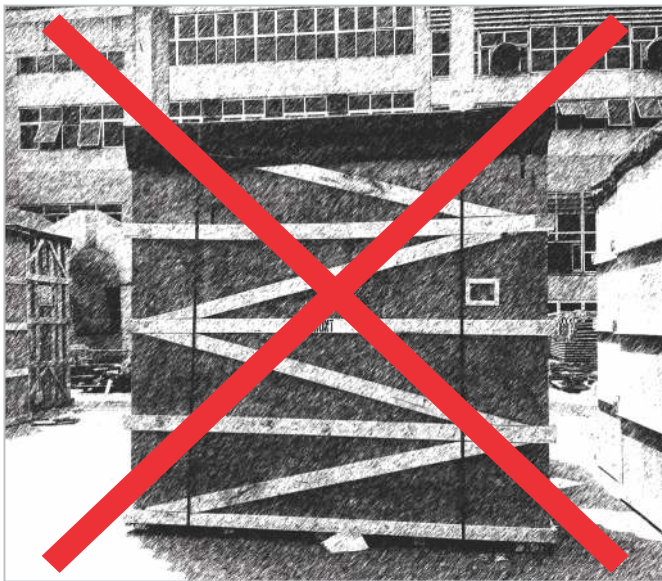
- OUTDOOR STORAGE SHOULD BE AVOIDED. Store all cases indoors, in a clean, dry and well ventilated place where seepage of water and condensation does not occur.
- Maintain a minimum temperature of - 5 C and humidity of less than 50%.
- If civil construction is being carried out in the vicinity, ensure that the PCC is completely protected from debris and dust.
- Keep proper tags / markings on the panels for easy traceability.
- Unpacking of the TUs at site is preferable. In case it becomes necessary to unpack the TUs during storage, make sure that packing of all the internal components e.g. covers on the relays and meters mounted on the door etc remain intact (Highlighted in the figure below). Also inspect the PCC for scratches, if any. Please use paint supplied with the loose materials to touch up scratch marks.



 The switchboard should be stored indoors with proper ventilation. Moist / corrosive environments may affect the metallic parts and cause their insulation to deteriorate.



GENERAL SAFETY

While shifting the panel from storage point to erection site:

- Use a lifting crane to load the panel on to the truck. Ensure that TUs are placed in a vertical position on the truck.
- Tie the TUs properly to prevent unwanted movement.
- Refer the previous section for TU handling instructions. (Page No.12).
- Personnel handling the equipment must be skilled and authorised to handle the intended voltage level.
- All working personnel must be aware of safety practices.
- Safety shoes should be worn so as to avoid the risk of any electric shock while at work.
- Gloves and goggles should be used while working in the proximity of hot and hazardous materials to avoid bodily injury.
- Appropriate tools and instruments should be used as stated on page no. 16 for precise workmanship.
- Suitable Caution labels and sign boards should be erected at the time of installation and testing of boards as a mark of caution.





INSTALLATION

Typical arrangements

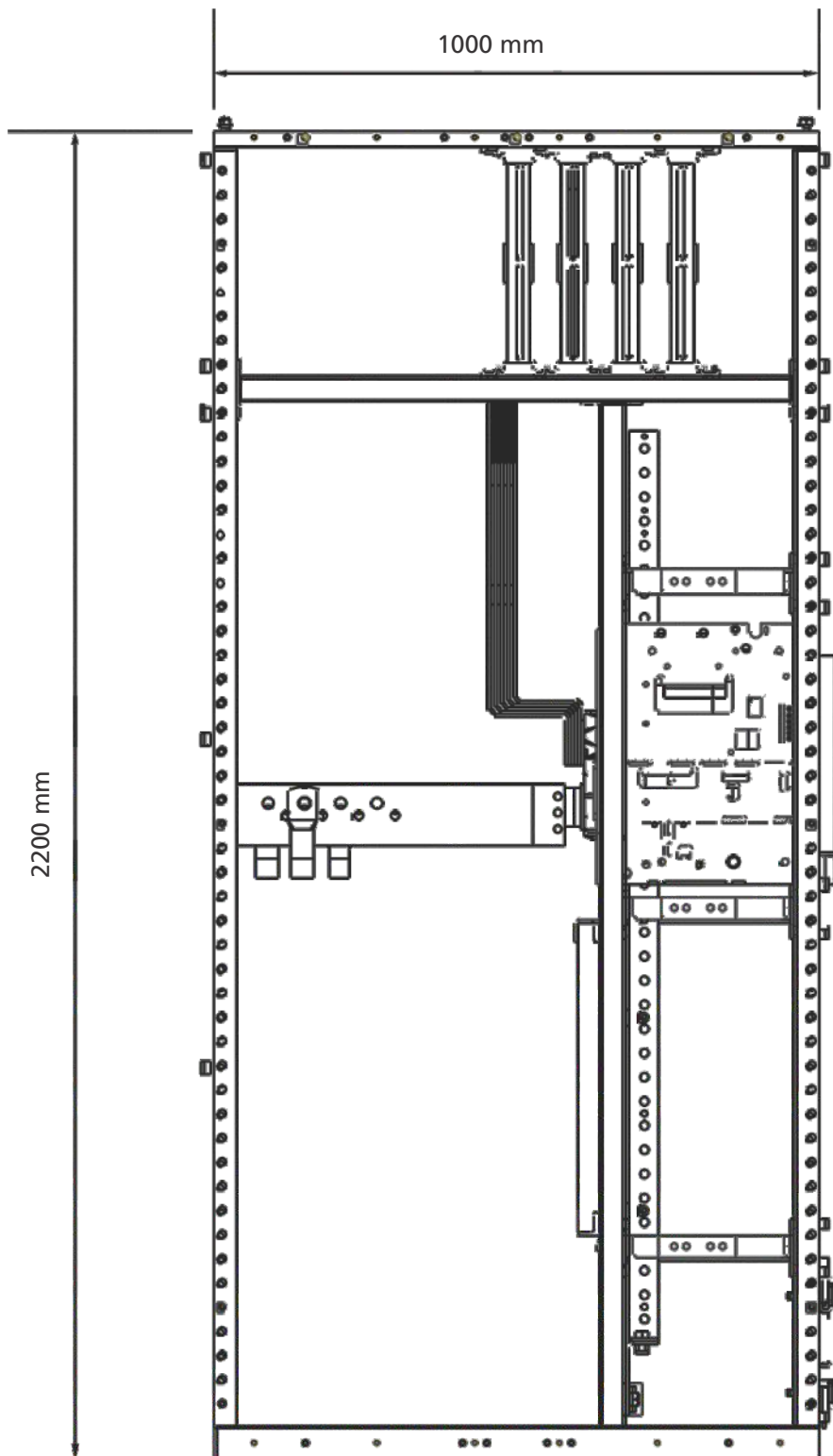

Power Control Centre

Figure 12 - Typical arrangements

TOOLS

- Torque wrench
- Bush Ratchet
- Hydraulic jack
- Rubber mallet
- Clamps



Figure 13 - Tools

SITE PREPARATION

1. The installation site must be clean and the surface even.
Use shims if the floor is uneven. An uneven foundation may cause misalignment of sections, bus-bars and hinged doors of the unit.
2. Walls and ceilings must be plastered with painting completed.
3. Doors and windows must be installed.
4. Openings in the floor, wall and ceiling for cables, conductor pipes, bars and ventilation must be in accordance with the construction drawings provided.
5. Supporting brackets, beams, enclosures and foundation frames must be assembled and painted.
6. If necessary, braces appropriate to the basic dimensions of the switchgear installation with cross struts corresponding to the panels must be assembled.

- ⚠ *Suitable indoor conditions must be maintained and necessary emergency exits must be provided in the switchgear room.*
- ⚠ *Excessive temperature fluctuations and high humidity should be prevented.*
- ⚠ *Condensation should be prevented.*
- ⚠ *If the plant's atmosphere is likely to contain excessive steam or reactive gases comprising sulphur or chlorine, ensure that the Switchboard is placed in a separate pressurized room.*

ERECTION

1. After TUs have reached the installation site, unpack the TUs and move the packing material to its allocated area.
2. Check if all components are in place as per your drawings (MBOM) and the packing list.
3. Vertical sections should be shifted sequentially into the installation site for ease of installation.
4. The TUs must be carried in an upright position to avoid the risk of toppling. Refer the section *Floor preparation & panel mounting*.

5. Place the first TU over the base channel frames erected in the floor concrete by the civil contractor. Check correctness of leveling (± 1 mm tolerance per meter is allowed) and alignment of panels & proceed as per General Arrangement (GA) Drawings.
6. Maintain clearances as mentioned in GA drawings. Provide sufficient space on all sides of the panel for personnel to work conveniently.

FLOOR PREPARATION AND PANEL MOUNTING

Mount the panel on the floor either by bolting or by tack welding with the ISMC base channel / base frame. The panel has an integral 50 mm base frame made of 3 mm sheet metal.

Follow the steps listed below to mount the panel:

- Grout / weld the ISMC base channel / base frame on the inserts on the floor. Ensure that surface is perfectly levelled.
- Place the panel on to the ISMC base channel / base frame.
- Refer Figure below for placing the panel on to the ISMC base channel / base frame

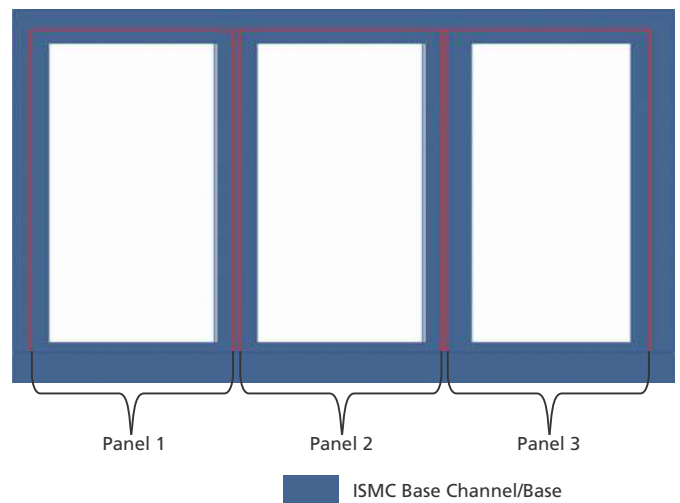

Figure 14 - Panel Mounting on ISMC Base Channel / Base Frame

- Tack-weld or bolt the panel with the ISMC base channel / base frame.
- When bolting the panel, drill the required holes in the ISMC base channel / base frame, so that it matches with the holes provided in the integral base frame.

Please ask for project specific drawings if you are bolting the panel to an ISMC base channel/frame. If you decide to tack-weld the panels to the base channels/frames, such drawings are not required Figure 14.

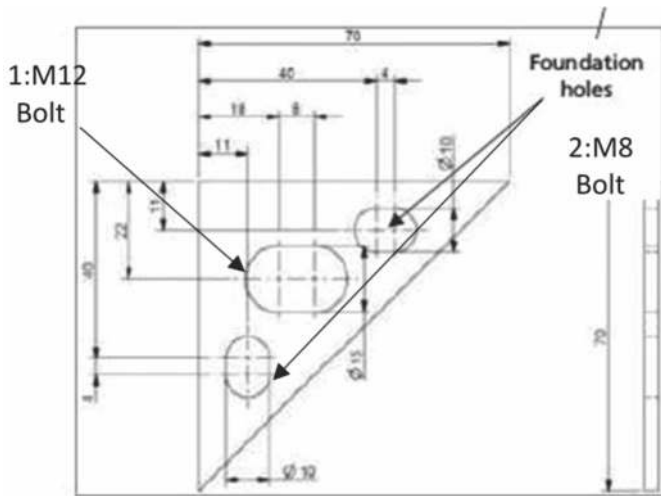

Figure15 - Integral Base Frame

The fixing the integral base frame using 2: M8 bolt or 1: M12 bolt.

If ISMC frame is used, 2:M8 holes to be used for fixing ISMC frame with panel bottom frame and ISMC frame to foundation base fixing shall be with 1:M12 bolt or with tack welding as mentioned above.

Bolt the panel at locations explained below:

PCC
For depth =600 mm
Mounting locations: 1 to 4

For 300W, 440w dropper panels,
1,2, 3 & 4 for all the depth.

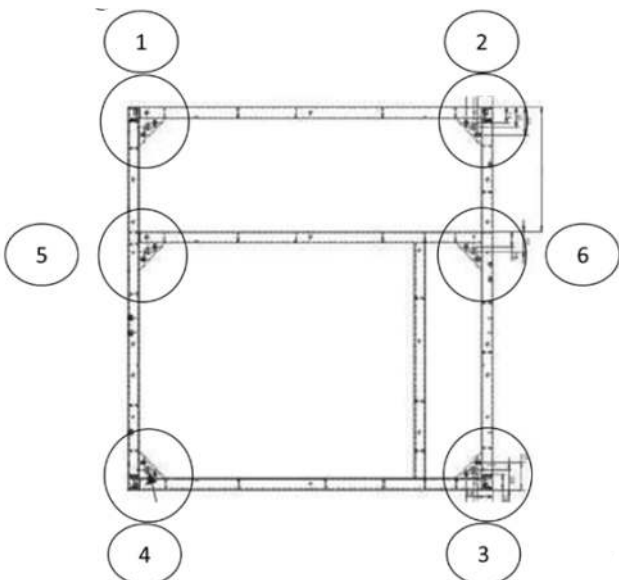

Top view of PCC Panel

The foundation holes in the locations marked above can be accessed from front & rear by removing the bottom gland plates.

A typical drawing for the ISMC base frame and the coupling of the integral base frame to the ISMC frame is as shown below.

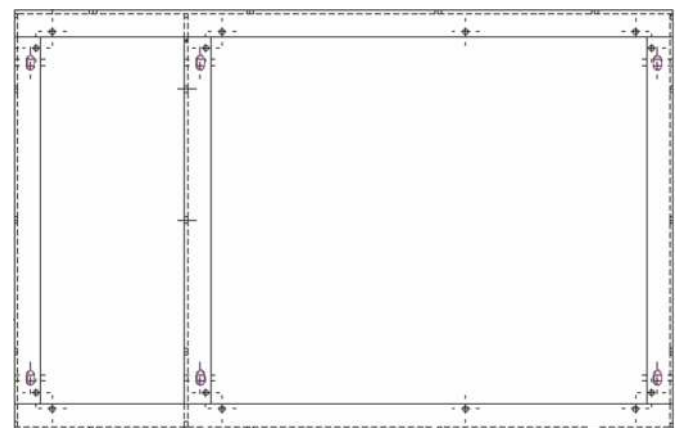
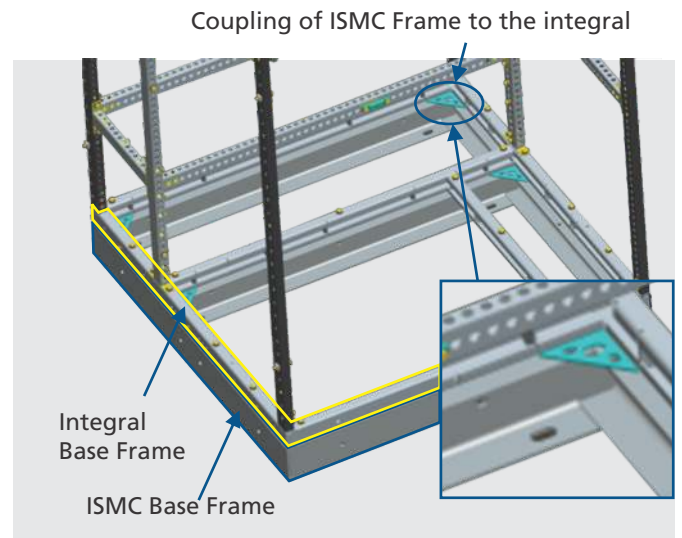

Figure16 - ISMC Base Frame



Ensure that the board is properly aligned while bolting / tack-welding.

INSTALLATION

CONNECTION OF TRANSPORT UNITS AND BUSBARS

1. For access to the horizontal busbars, remove top plates and hoods (if provided) by removing all the bolts provided on the top Figure 16.
2. Remove the fish plates provided on the right side of the busbar to connect it with subsequent TUs placed sequentially.
3. Clean unplated/ bare joints. Wipe them with a soft, dry cloth and then immediately apply contact grease on them. Hindustan Petroleum, MPL (EXXON) / Petroleum Jelly J. P. grade contact grease or equivalent is recommended.
4. Bolt adjacent TUs together and holes provided in top/bottom frames. 4 Nos of coupling bolts to be used per vertical channel front and rear coupling. This should be done before joining the busbars.
5. Join horizontal bus bars using the fishplates as shown in Figure17.

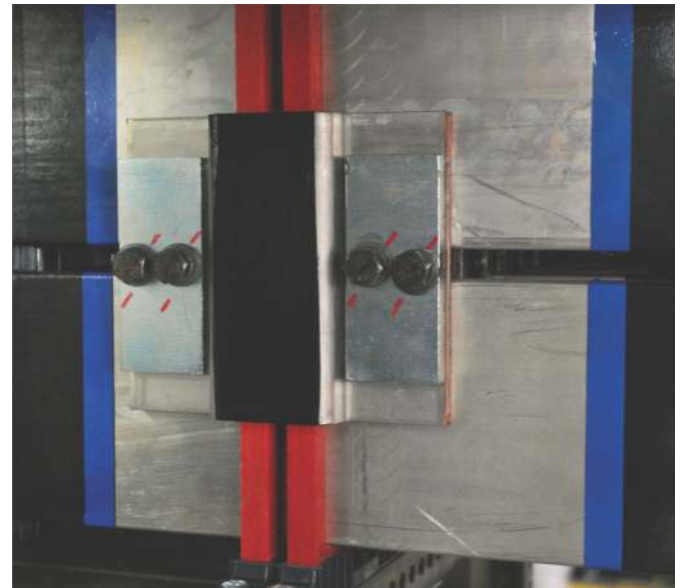

Figure 18 - Busbar joining

6. Tighten all electrical connections, except Hole-less Horizontal busbar joints (HBB), with a torque wrench to the torque values as mentioned in table no.3. For Hole-less HBB joints, torque values to be as mentioned in table 3A Figure18.

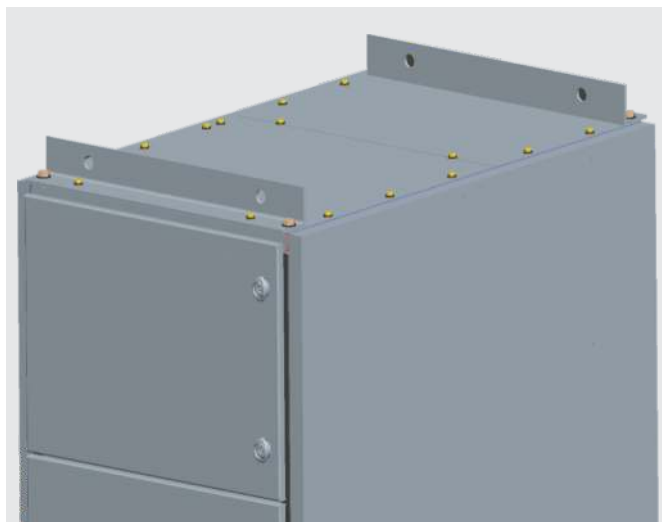

Figure 17 - Top plate



Figure 19 - Tightning of Busbar joints

! Ensure bus bars are properly aligned so that there is no strain on any of the support insulators.

Size of bolt Torque in m.kg

Thread (Bolt size)	Kgfm		Nm		Socket No. (mm)
	Normal Bolt (Grade: 4.8)	High Tensile Bolt (Grade: 8.8)	Normal Bolt (Grade: 4.8)	High Tensile Bolt (Grade: 8.8)	
M6	0.38	1.05	3.7	10.29	11/10
M8	0.85	2.5	8.3	24.51	13/12
M10	1.88	4.7	18.8	46.09	17/16
M12	3.2	6.5	31.38	63.74	19/18

Table No. 3

! For aluminum bus bar system normal torque to be applied even if the bolt is HT. HT torque values are applicable only for hole less bus bar joints.

Thread (Bolt size)	Cumulative thickness of conductor at joint (T) mm	Torque (kgfm)	Socket No. (mm)
M12 High Tensile Bolt (Grade 8.8)	T<20	5.75±0.25	18/19
	20<T<35	6.25±0.25	
	T>35	6.75±0.25	

Table No. 3A

7. Join the auxiliary busbars by joining the auxbus fish plate provided for the same in the left side TU Figure 19.



Figure 20 - Auxbus joining

Procedure for Single-Deck busbar coupling and Torque Verification

1. Top MS clamp support (highlighted in yellow) to be removed for verifying the torque.
2. Torque to be verified using Tonichi make torque wrench along with standard 16 mm socket (SHI5DX16).

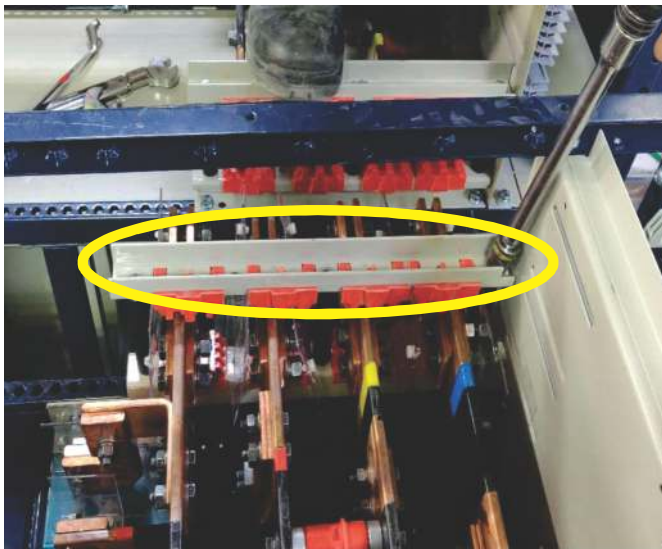

SHI5DX16

3. Once the top support is removed, tightening & torque checking is done in sequential manner from B-Y-R-N.
4. The outer most hardware is tightened first with open end / ring spanner (Size 16 - 17 mm) and torque is verified followed by inner hardware.
5. After verification, clamp support to be re-assembled.



Outer H/W

(Refer figure of Inner H/W on next page)



Inner H/W

CONNECTION OF EARTH BARS

PCC (TS) - PCC (TS)

1. For single front panels, open the rear door of the panel to access the horizontal earthbar.
2. In case of a back to back arrangement, open the cable alley to access horizontal earthbar.
3. Remove the fishplate provided on left hand side TU to connect it with subsequent TUs placed sequentially.
4. Join the earth bars using the fishplate provided and check correctness.
5. Tighten the connection with a torque wrench to the torque values as mentioned in Table no. 3.

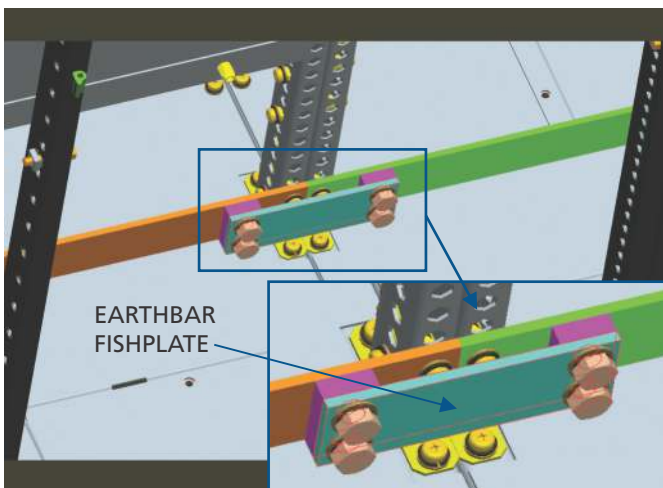

Figure 21 - PCC - PCC Earthbar Coupling

PCC (TS)-MCC (TX)

1. Open the rear door of the PCC.
2. Remove the fishplate provided at the end of horizontal earthbar at the bottom.
3. Connect the fishplate with the already extended MCC earthbar.
4. Tighten the connection with a torque wrench to the torque values as mentioned in Table No.3.

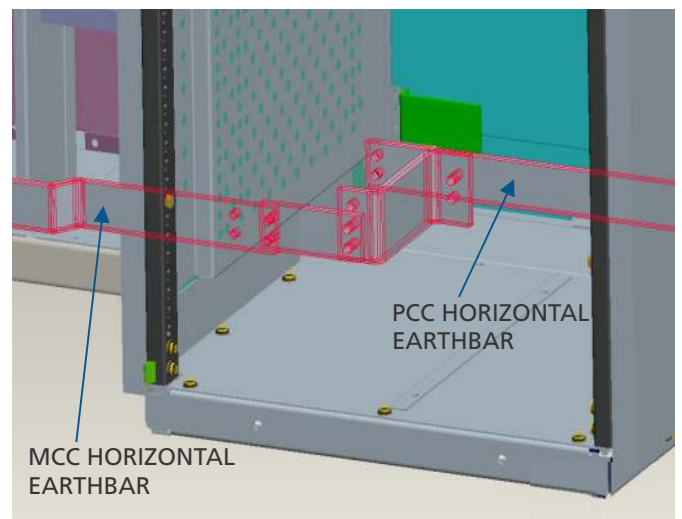

Figure 22 - PCC - MCC Earthbar Coupling

INSTALLATION

POWER CABLE:

TOP CABLE ENTRY

1. Remove the top plate Figure 23.
2. Punch the required holes on the top plate depending on cable size and gland type.
3. Follow the instruction given under cable termination.

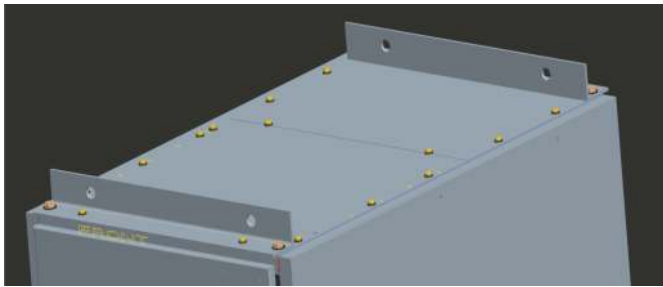

Figure 23 - Top plate

BOTTOM CABLE ENTRY

Remove the gland plate-provided at the rear bottom side of the panel in two sections Figure 24.

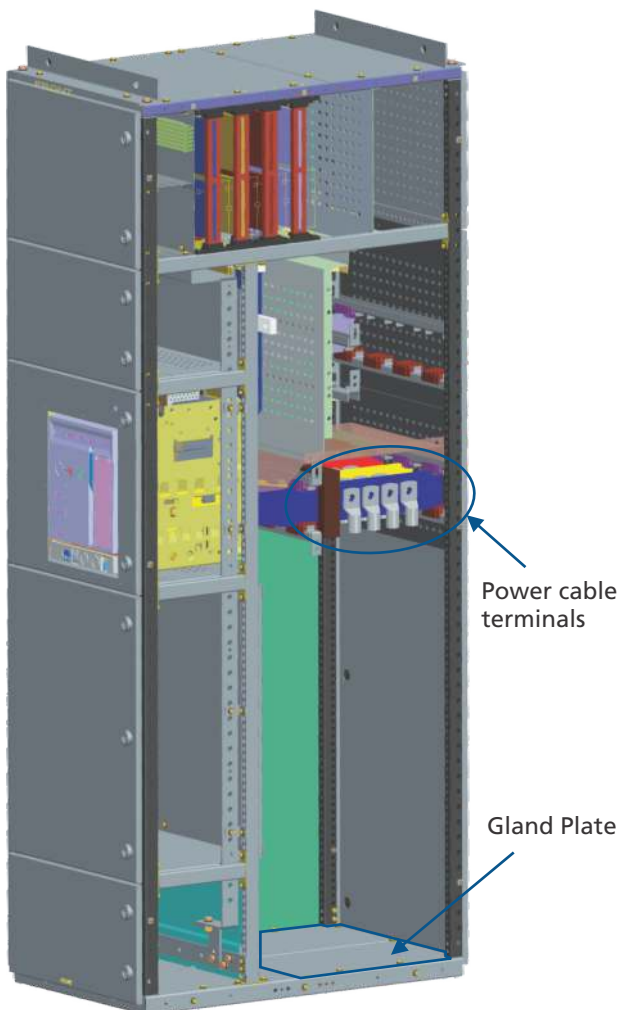

Figure 24 - Power Cable terminals

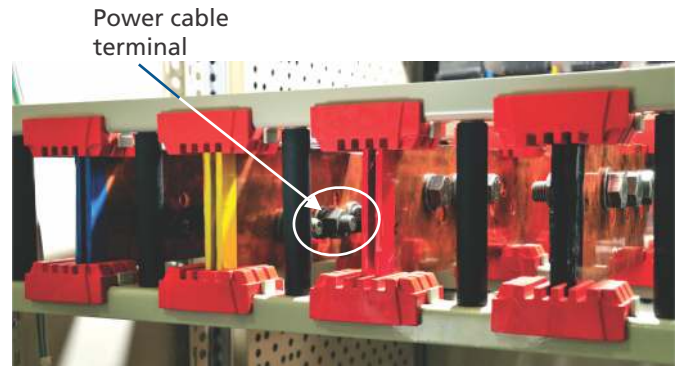
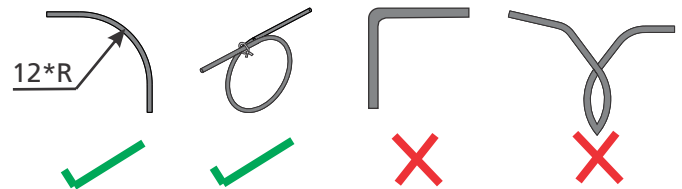

Figure 25 - Power cable terminals

Punch the required holes on the gland plate depending on cable size and gland type Figure 26.



Figure 26 - Power cable terminals bottom cable entry



Cable termination:

1. Remove insulation from cable ends without damaging the conductor strands.
2. In case sector shape conductors are used, form the conductor using a circular forming die.
3. Refer following section for terminating power cables.
3. Clean the conductor and coat immediately with inhibiting compound like petroleum jelly.
4. Crimp the lug terminals properly as improper crimping may result in higher temperature rise at the joints.
5. Coat the lug barrel with an inhibiting compound from inside.



Forming should be done prior to cleaning and applying inhibiting compound.

6. Use lugs with serrated barrels for crimping aluminium conductors (Serration increases the pull strength after crimping. It also cuts through the oxide film, if any, formed on the conductor).
7. Use proper crimping dies, as recommended by the lug manufacturer. For aluminium conductors, use ring or hexagonal dies. Ensure that the die surfaces meet during crimping. Incomplete crimping will result in higher temperature rise at the joints.
8. Ensure proper clamping of cables on the glands and cableclamps to avoid weight of cables acting directly on the termination.
9. Block all the unused holes Figure 26.
10. Ensure no free hanging of cable wire.
11. All cable wires should be supported appropriately & rigidly at required no. of locations. Ensure cables are at a safe distance (min 50 mm) from live parts.

BUSDUCT TERMINATION:

TOP BUSDUCT ENTRY

- Remove the top plate of the incomer or outgoing feeder.
- Connect the flats of the busduct with the links at the end of the busduct riser using the flexibles Figure27.



Figure 27 - Top Busduct termination

BOTTOM BUSDUCT ENTRY

- Remove the gland plate provided at rear bottom side of the feeder.
- Connect the flats of the busduct with the links at the end of the busduct link using the flexibles Figure 28.

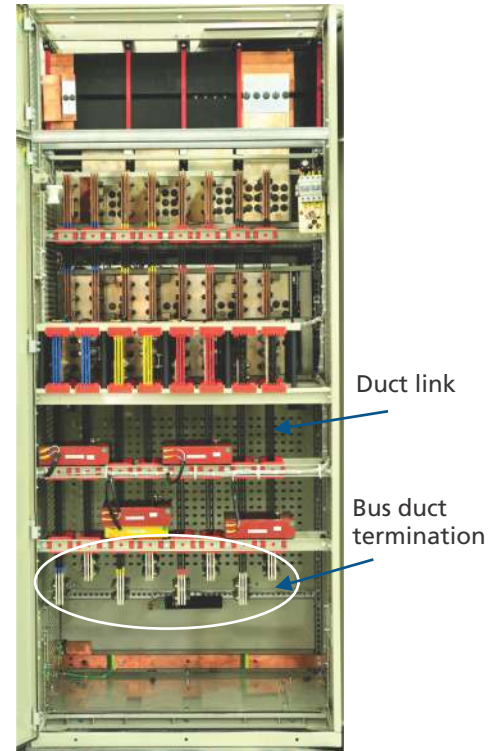

Figure 28 - Bottom Busduct termination



In case Busduct flats and links are of different material, use bimettalic flexibles to joint the busduct flats and links.

CONTROL CABLES:

1. Remove the gland plate /base plate.
2. Punch the required holes on the gland plate / base plate depending on cable size and gland type.
3. Route the wires through the holes punched in to the base plate and terminate the cables in the terminal block provided at the bottom of the panel as per the schemes.

- Use of copper wire is recommended.
- Ensure that the connection of the wire is as per the scheme drawing provided.

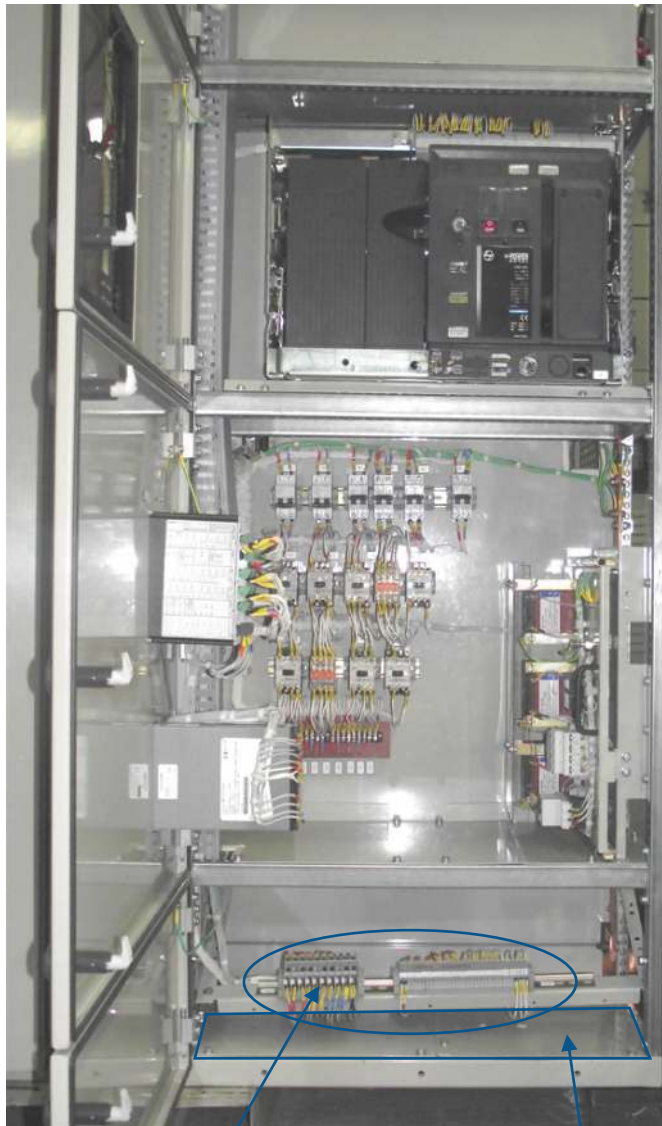

Terminal Block Base plate/ gland plate

Figure 29 - Control Cable terminals

Interpanel wiring

1. Wiring is through the horizontal wire-way at the top along the auxiliary bus.
2. For wiring, separate terminals are provided in the left hand side of the right most TU which are named XS-YY (X - terminal no. and YY - panel no. (01, 02, 03 etc.)). The wire bunch to be connected to these terminals is in the left-hand side transport unit. The wires have ferrules with the terminal no. and should be connected their respective terminals. The no. of terminals and no. of wires to be to be connected are equal.

For example, consider the panels and transport units shown in the sketch. The transport unit (TU) consists of panel 1F and 2F, while TU-2 consists of panel 3F and 4F. The terminals named 1,2,3... -XS03 are mounted in panel 3F as shown in the figure. The mounted terminals are connected to their respective equipment in panels 3F and 4F. The wires going from TU-1 to TU-2 are bunched and kept with panel 2F. The wire which is to be connected to terminal 1 of panel 3F will have a ferrule marked 1XS03 at the end of it and will be kept in 2F.

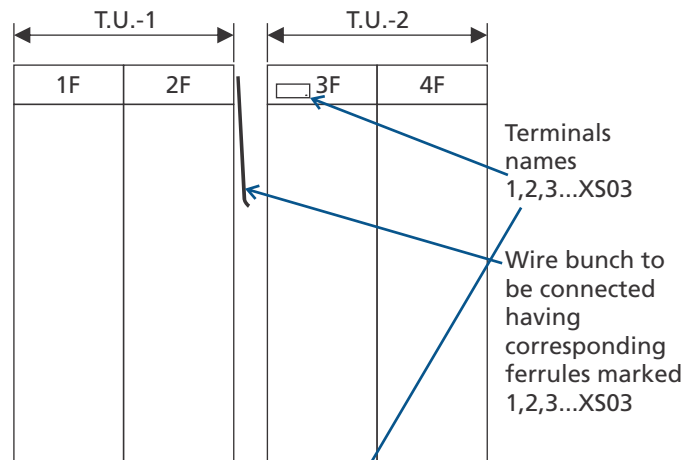
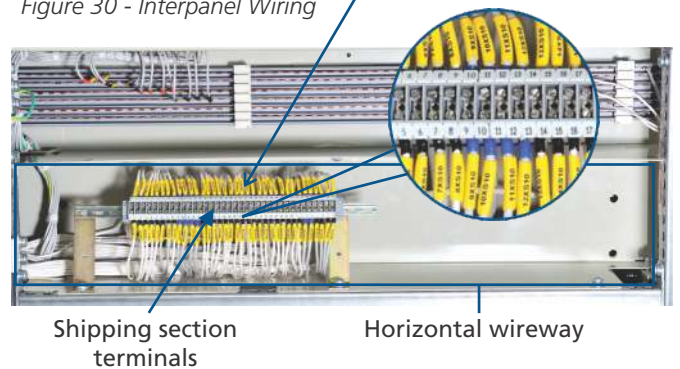

Figure 30 - Interpanel Wiring



Shipping section terminals

Horizontal wireway

Installation of loose material:

Metering and control devices:

- Unpack the metering and control devices (like meters and relays) if they were sent as separate packages.
- Position the device in the apt cut-out or base plate provided.
- Wire them as per the scheme drawing provided.
- Refer to the device leaflet for further details about the device.
- Carry out the settings of magnitude and time delay (if any) for the installed protective and control devices as shown in scheme drawing and MBOM (Master Bill of Materials).
- Place the terminal covers properly to adhere to stated ingress protection (IP) level.
- Check alignment of operating handles for all switches.
- While dispatching the switchboard, secondaries of all current transformers are shorted. Remove these shorting while connecting relays/meters and store them separately.
- Ensure again that all doors are closed and no connection is left loose.



Figure 31 - Unpacked ACB

ACB

- Unpack the ACB properly to avoid damaging it using crowbar Figure 32.
- Open the ACB compartment door using the camlock key provided.
- Rack out the cradle using the racking handle.
- If cradle movement is not smooth, apply contact grease. Also check for the free movement of safety shutters.
- Put the ACB on the cradle with the help of ACB lifting truck Figure 33.

Note that ACB lifting truck will be supplied only if asked by the customers.

In case if you dont have ACB lifting truck please contact the sales team for ordering the same or email to AtYourService@Intebg.com



Figure 32 - ACB lifting truck

Loading in panel:

1. Pull-out the Cradle Rails & ensure that position indication shows 'DISCONNECTED'

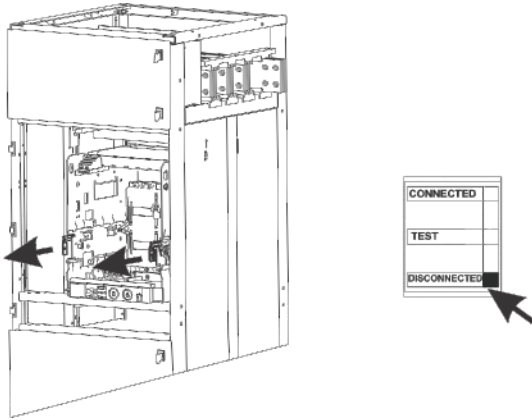

2. Load the ACB using crane. Even bottom trolley can be used.

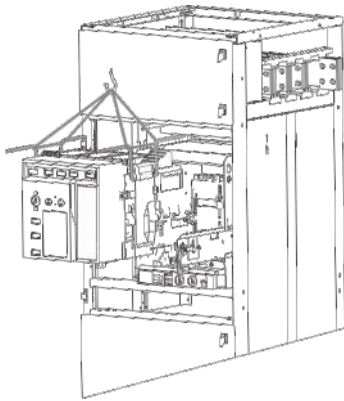

3. Ensure that ACB rests correctly in 2 slots on either side of cradle rail.

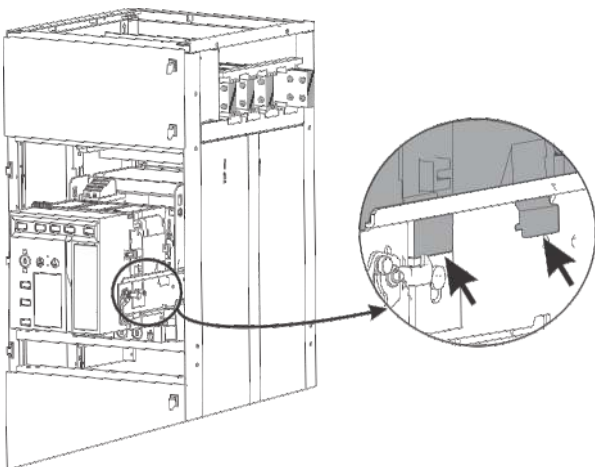

4. Gently push the ACB to DISCONNECTED position and close the Panel door.

If equipped with Rating Error Preventor, Cradle will not accept ACB of different rating.

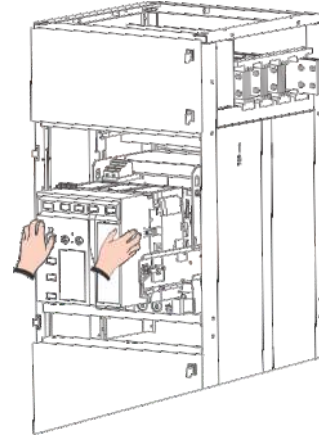

5. Keeping the OFF button pressed, open the Racking Shutter. In case panel door is open, also gently defeat Racking Interlock.

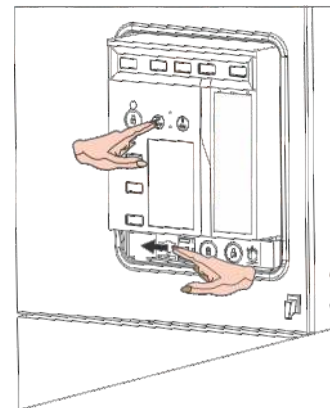

6. Rack-in the ACB to Service position. Two almost-simultaneous 'Click' sounds confirm 'CONNECTED' position.

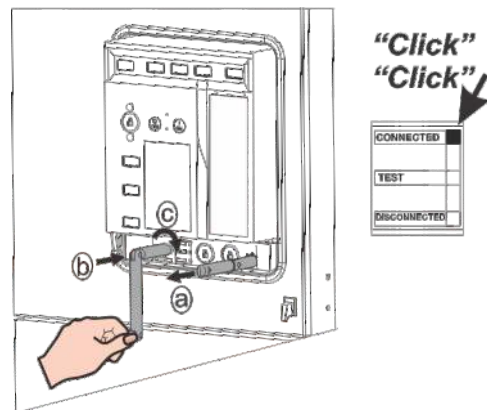

! Improper loading of ACB may lead to personal injury and damage to product.

! Excessive forceful racking-in beyond Connected position lead to product damage.

INSTALLATION

Control Transformers

1. Unpack the Control Transformer.
2. Open the compartment door in which the Control Transformer is to be installed.
3. Bolt the Control Transformer to the base plate.
4. Terminate the primary and secondary wires of the transformer on the respective terminals.
5. The primary wire has a ferrule with capital letters while that of the secondary is with unicas Figure 32.
6. Check the connections and tighten the bolt.

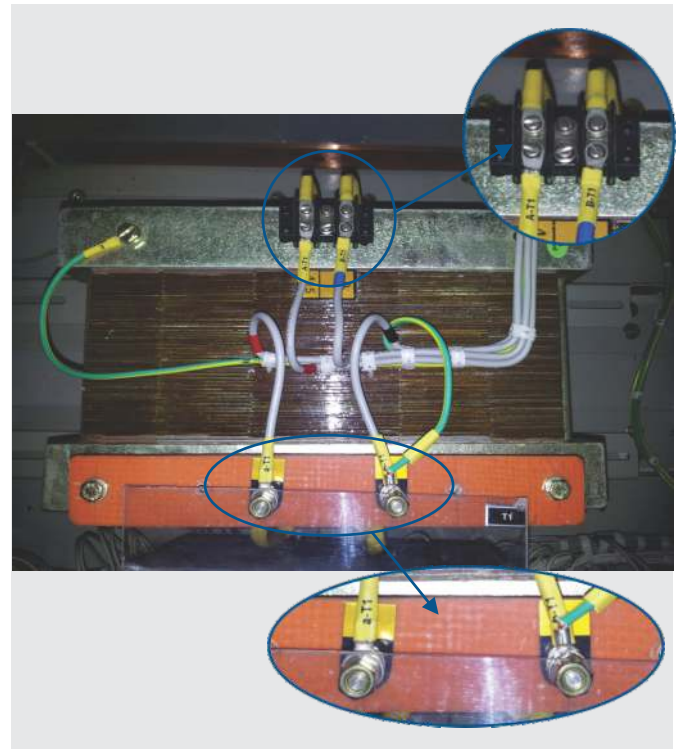

Figure 33 - Installation of Control Transformer

INSTALLING AN EXTENSION PANEL

To join an extension panel to existing TS,

1. Remove the end cover of existing TS at the joining end Figure 35.
2. Follow instructions listed in 'Connection of TUs' under Installation on page no. 19.
3. Necessary busbars / fishplates are supplied with the extension panel.
4. Place the end cover on the newly added panel.



Figure 34 - Extension of Panel

 Ensure that both power and control circuits are switched off before taking the end cover off the TU.



2-F-B
1000A
ANNUAL HOUSE

Indicator lights (Green, Red, Yellow, Blue)

Digital display showing '2.5'

BREAKER CONTROL
NEUTRAL
CLOSE

OMEGA
UV1-105
6, 1 1000 A
Type: 100V
Category: B

V_N	230 V
V_{max}	255 V
V_{min}	205 V
V_{max}	255 V
V_{min}	205 V
V_{max}	255 V
V_{min}	205 V

IEC 60898-2
EN 60898-2
EN 60947-2
S 100-1000/10
MADE IN SWITZERLAND

FOR 2FA

FOR 2FA

2-F-C
AUXILIARY EQUIPMENT



SITE TESTING

TESTING YOUR SWITCHBOARD

1. Keep all power circuit switches ON.
2. Isolate all parallel paths.
3. Ensure all power circuits are connected.
4. Measure all insulation resistance (IR) values between phases with respect to earth, phases with respect to neutral and between phase and earth with respect to neutral with a 500 V megger and compare with the table below.

A) Insulation Resistance Test with 500V Megger before and after H.V.Test (All values in M.ohms).

	R	Y	B	N
E	0.5	0.5	0.5	0.5
N	0.5	0.5	0.5	~
B	0.5	0.5	~	~
Y	0.5	~	~	~

In case megger trips while testing, go on isolating one panel from the switchboard till the fault is found.

B) Dielectric Strength Test at 2.5KV for 1 Sec.

Check (phase)	With respect to
a) R/Y/B/NE
b) R/Y/BN
c) R/YB
d) RY

5. Carry out HV test at 2 KV for control circuits and at 2.5 KV for power circuit for one second and limit the voltage to 85% of the preceding value for every consecutive test.

TESTING OF AIR CIRCUIT BREAKER(ACB)

1. Check rating & type of the ACB are as per MBOM drawing.
2. Check the door interlocks of the ACB. Door should not open when the ACB is in SERVICE or TEST position. In these positions, it should be possible to open the door only with door interlock defeat facility.
3. Carry out electrical function checks on the ACB with respect to control schematics. (Simulating each logic condition).

4. Check anti pumping operation of the ACB. (Press the closePB (Push Button) and keep it pressed, the ACB closes). Now reset the trip command and then press the close PB, ACB closes now. Hence the anti pumping feature of ACB is checked.
5. If the ACB has in-built protection release, it should be tested with the respective testing kit.
6. Carry out functional tests on the ACB as per control wiring scheme of the respective feeder.

TESTING POTENTIAL TRANSFORMERS (Voltage Transformer and Control Transformer)

1. Check nameplates and ensure they are as per drawings.
2. Check PT Secondary is wired correctly with proper gauge of conductor.
3. Check PT mounting and ensure they are adequately supported.
4. Check PT circuit's earth link.
5. Check the polarity of PT. Using a battery operated polarity tester, check that positive EMF is induced between terminals S1 and S2 when a positive current pulse is applied between P1 to P2.
6. Check ratio of all cores. Conduct ratio test by applying 1 phase 240V across the primary. Note voltage at secondary. Calculate the ratio tabulate and compare the value with the nameplate values.
7. Measure winding resistance.
8. Check tightness of all connecting terminals.

TESTING OF METERS AND TRANSDUCERS:

1. Inspect all meters and transducers for proper mounting and for any damage.
2. Test with calibrated meters.
3. Check CT and VT connections with particular reference to their polarities for power type meters wherever they are provided.

4. Check for the earthing of meters and transducers as per the drawing.

TESTING OF RELAYS:

1. Inspect for proper mounting and for any breakage.

2. Ensure all gagging of moving parts are removed.

3. Check nameplate details as per specification.

4. Set the relay as per setting sheet, (protection co-ordination) and check for its operation at set values.

TESTING CURRENT TRANSFORMERS (Cts):

1. Check nameplates and ensure CTs they are as per drawings and specifications.

2. Check whether the CT secondary is wired correctly with proper gauge of conductor.

3. Check CT secondary links are properly connected as per the scheme drawing.

4. Check CT mountings and ensure they are adequately supported and clamped.

5. Check polarity of CT. Use a battery operated polarity tester. Depending upon the type of CT apply a positive pulse at P1 and a negative pulse at P2 (where P1 and P2 are two ends of the coil). Connect a null deflection galvanometer and observe the direction. It should be towards the right hand side.

6. Measure winding resistance of CT secondary using a multi meter in ohmmeter mode in case of protective CT core to ensure that the CT secondary is not open.

7. Check tightness of all bolts, clamps connecting terminals.

8. Check for earthing connections of CT is as per drawing.

CHECK	POTENTIAL PROBLEMS
Verification of vendor documents	Incomplete documentation
Verification of General Arrangement & Mechanical check <ul style="list-style-type: none"> • Appearance (Visual) • Dimension • Verticality & Waviness 	Cleaning Wobbling of doors Misalignment of pillars Alignment of handle
Powder Coating: <ul style="list-style-type: none"> • Surface Finish Glossy or Matt • Paint Shade • Dry Film Thickness 	Orange peel effect, Bubbles, Dent Marks, Pinholes Paint shade difference, low gloss DFT low / high
Busbar Arrangement	Busbar coupling not ok Fishplate & hardware missing
Busbar & Power Joints Tightness	Loose joints, No red marking, Wrong H / W size
Pull test for crimping and termination and visual inspection of wiring	Loose crimping Wrong lug used Loose termination Poor wire bunching & dressing
Clearance	Low clearance
Partition Provision (Form of Separation)	Shroud not provided at Live terminal, Cover / Barrier missing
Degree of Protection (IP)	Pinholes at door corners, control plate gasket not proper, extra holes on pillars / end cover / doors
CT Polarity	Wrong CT wiring, mixing of protection & metering CT wires, neutral CT connection wrong
Current Injection (Primary / Secondary)	Wrong wiring of trip circuit / protection circuit, wrong termination at relays
Insulation Resistance (Megger)	Low IR value
Dielectric Test (High Voltage) for Power & Control Circuit	Presence of foreign material in Busbar zone, insulation puncture

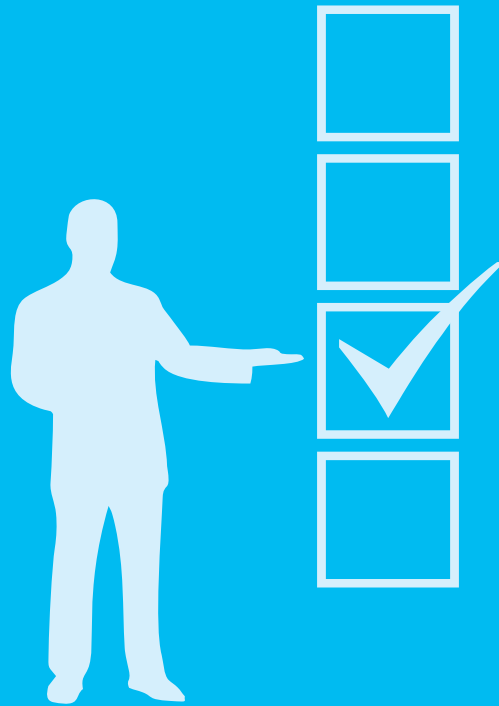

PRE-ENERGISING CHECKS

PRE-ENERGISING CHECKS:

Ensure the following checks are carried out before energizing:

Sr.No.	Check Point	OK
1	Overall Appearance & surface finish	
2	Verticality of Panels	
3	Room ventilation	
4	Fire Extinguisher	
5	Rubber mats of grade 1 100 V	
6	Loose supplied item fitted	
7	Verification of BOM as per GA drawing	
8	Tightness of busbar Joints	
9	Wiring check as per scheme drawings	
10	Phase sequence / Polarity check	
11	CT & PT ratio check (on Sampling)	
12	Insulation Resistance	
13	High Voltage Test (Power Circuit)	
14	High Voltage Test (Control Circuit)	
15	All doors closed	



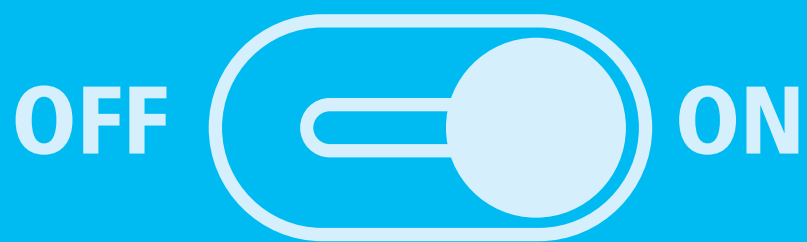

COMMISSIONING

General parameters which must be checked before commissioning the switchboard are :

- Control and Indication
- Remote Operation (if any)
- Electrical Interlocks (if any)



Congratulations!

Your switchboard has now been commissioned.

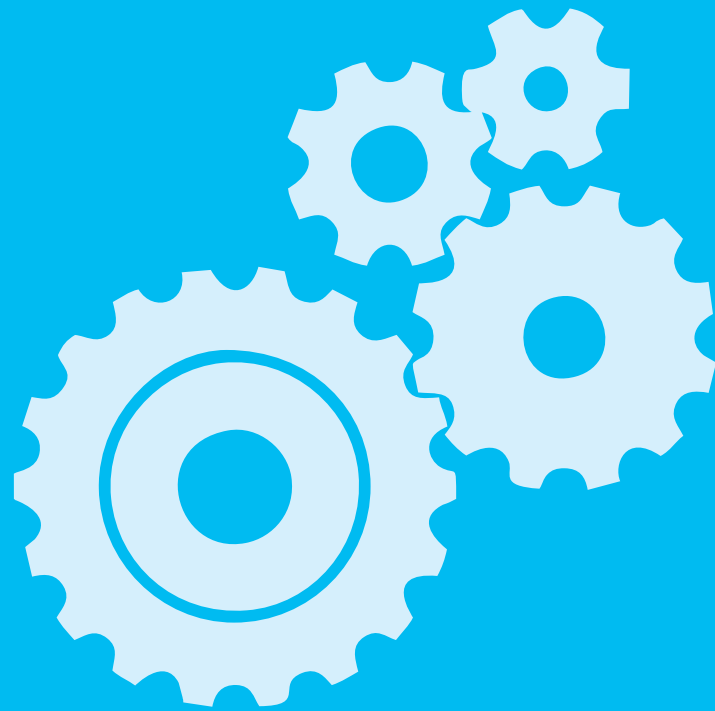

OPERATION

Racking-out

1. For D/O ACB remove the Transportation Cushion (2 Nos.) & its instruction label, before doing racking operation of the ACB.

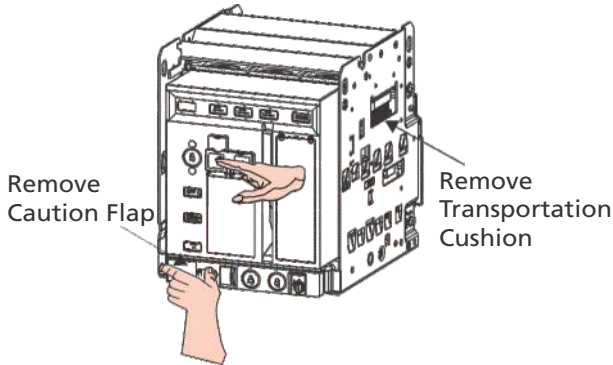

2. Keeping OFF button pressed, open the Racking Shutter. In case ACB is out of the panel or the panel door is open, gently press Racking Interlock to defeat it. Rack-out the ACB to Disconnected position.

Note: Once racking shutter is opened, the ACB can not be closed, even by an electrical closing command.

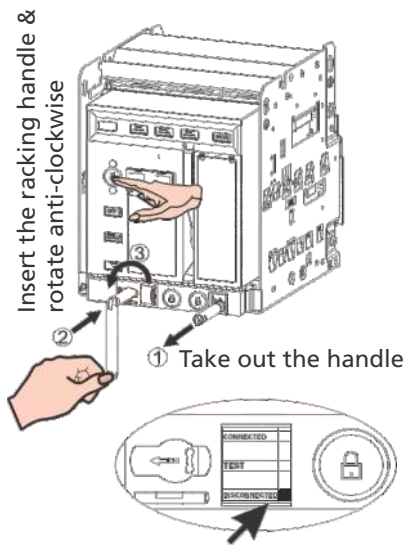

Note: After removing the racking handle, the racking shutter automatically recloses only in distinct 'Connected' / 'Test' and 'Disconnected' positions. Hence, ACB cannot be closed in any Intermediate positions to ensure User safety.

! Excessive, forceful Racking-out beyond Disconnected position may lead to Product damage.

3. Pull the ACB out using pull-out handles.

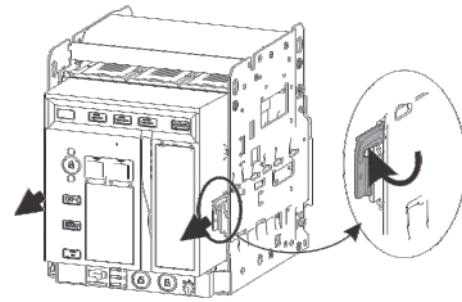

ACB Interlocks:

- **ON-OFF Button padlocking:**

To prevent unauthorized access, ON / OFF buttons can be padlocked or sealed, together or individually.

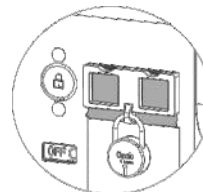

Padlocking both buttons

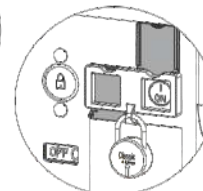

Locking any one button

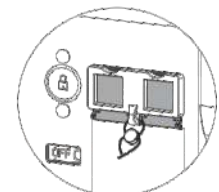

Sealing Either/Both buttons

- **Sealing the Release cover:**

Protection setting for Release can be secured using a standard lead seal.

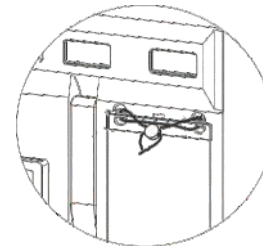

- **Safety shutter padlocking:**

Users can padlock top or bottom part of the Safety shutter to secure access to Line and/or load side.

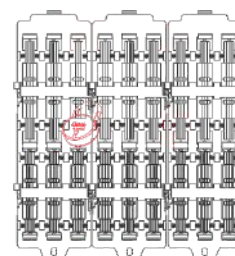

• **Racking shutter padlocking:**

Tools required: Screw Driver (Tip width 3 mm)

To prevent inadvertent racking operation, racking shutter can be padlocked, when ACB is in distinct Service, Test or Isolated positions and racking shutter is closed. Upto 3 padlocks can be used at a time.

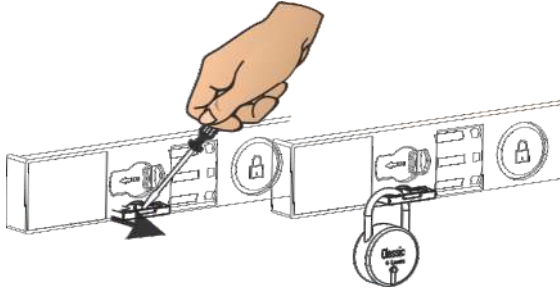

• **Locking OFF button:**

ACB can be locked in 'OFF' condition to prevent unauthorized 'ON' operation. This feature is mainly used for interlocking with other ACBs or electrical devices in an electrical scheme.

Press the 'OFF' button and turn the key. When key is removed, the ACB remains locked in OFF position. For switching the ACB 'ON', reinsert the key & turn to release OFF button.

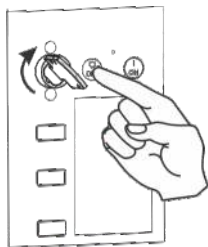

• **Door Interlock defeat:**

Tools required: Philips Head Screw driver (Tip number 2) or Screw driver (Tip width 6 mm)

If the ACB is equipped with Door interlock, panel door cannot be opened when ACB is in Service condition.

If it is necessary to open the panel door with ACB in Service condition, Door Interlock can be defeated as illustrated herewith.

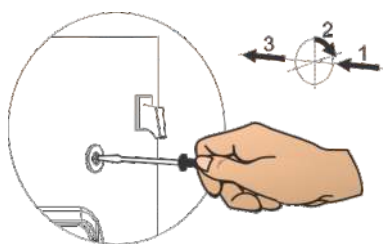

! Opening panel door when ACB terminals are live, may lead to electric shock and personal injury.

Racking Interlock defeat:

Tools required: None

Racking interlock prevents opening of racking shutter and thus, racking in / out of the ACB when panel door is open.

If it is necessary to rack-out the ACB with panel door open, racking interlock can be defeated. For opening racking shutter with panel door open, gently push the racking interlock lever in addition to keeping 'OFF' button pressed.

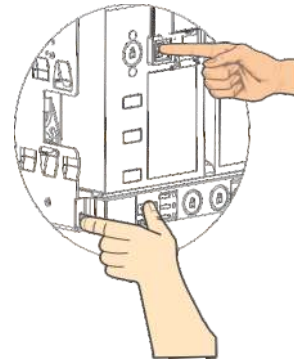

! It is recommended to carry-out racking operation only with panel door closed.

ACB Panel Indications

ACB panel has following indications on it –

- Green indicating lamp - Breaker 'OFF'
- Red indicating lamp - Breaker 'ON'
- Amber indicating lamp - 'AUTO TRIP'
- Blue indicating lamp - 'SPRING CHARGED'
- R, Y, B Phase indications.
- ACB front facia indication –
- OFF / ON Indication.
- 'Spring Charged' indication with Yellow color and discharge indication with black color.



Figure 35 - Front facia of ACB



2-F-C AUXILIARY EQUIPMENT FOR 2F-A & B

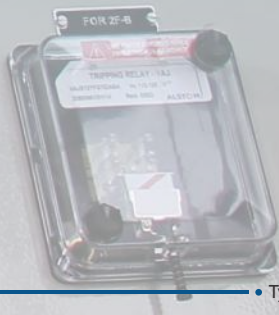
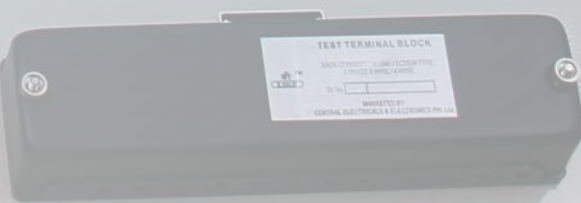
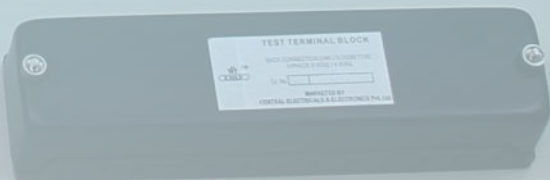



MAINTENANCE

PRECAUTIONS

1. Switch off the incoming power supply before removing top plates and side covers. Isolate incoming power supply.
2. For safety of personnel, while working on bus bars, provide temporary earthing using a metallic chain/strip near the work place. Remove this earthing only after the job is completed.
3. Switch off the control supply. Isolate remote control voltage sources.
4. Measure busbar voltage to ensure that bus bars are de-energized.
5. Ensure that only qualified personnel are permitted to use the defeat mechanism to gain access to an energised compartment.
6. Do not attempt to withdraw the unit or disconnect any terminations when the defeat mechanism has been used to open a compartment door.
7. Current transformer primaries must not be energised when secondaries are open circuited.
8. Short all CT secondaries.
9. In case of shutdown on only one feeder, padlock the power switch in OFF position.
10. After maintenance, if TS is going to be de-energised for a longer period, switch on the panel space heaters to prevent moisture condensation on the cables/insulators.

ROUTINE CHECKS

Carry out the following checks regularly:

1. Inspect all devices every two months to ensure that the equipment is in proper working order.
2. Check tightness of bolted joints (mainly Busbar) Figure 36.
 - prior to energisation
 - six months after load is connected
 - one year after the second check and then once a year



Figure 36 - Tightening of Busbar & Dropper Joint

3. Inspect all wiring for wear and cuts every two months.
4. Clean and lubricate the stab-in contacts once a year with HP MPL (EXXON) grease.
5. Remove burnt out fuses if any.
6. Check terminal block contacts for loose connections.
7. Examine indicating lamps and replace if required.
8. Ensure all safety interlocks are functional and in proper working order every two months.
9. Look for indications of overheating, sparking or insulation breakdown on the busbars.
10. Inspect all auxiliary and control circuits every two months for desired functioning.
11. Grease racking screw and telescopic rails at least once a year. Use grease 'HP-LETHON-2' or 'SYNTHOLUBE-20' of HJ Leach & Co.
12. Ensure that the earth wires are connected to the main earth bar (except electronic device earthing).
13. Ensure no tools or loose materials are left inside the TS as these can cause faults.
14. Keep the switchboard free of dust. Use a vacuum cleaner to remove the dust.

Do not operate equipment whose arc chutes are removed.

Overheating at terminals and joints can result in serious accidents including flashovers. Regular temperature checks at termination using an 'Infrared Temperature scanner' will help to detect any overheating for timely preventive action.

If ACB is not being racked-out in a year, it is recommended to carry-out racking operation of the ACB as a part of routine maintenance.

ACB Maintenance:

Nature of Maintenance	Schedule/Frequency	Actions
Routine	Quarterly	Temperature check at termination
	Yearly	Open & Re-close the ACB
		Rack-out & Rack-in the ACB
		Inspect Arc Chutes for erosion
	1 Year or 500 operations (whichever is earlier)	Inspect Contacts for erosion
Specific	When any Electrical accessory needs replacement	Greasing of Operating Mechanism
	When ACB clears a major fault	Replace the specific accessory
		Inspect Arc Chutes for erosion & replace, if required
	In case of an abnormal external event, such as flashover in panel	Inspect contacts for erosion & replace Main Contacts, if required
		Inspect Jaw Contacts & replace, if required
On completion of Electrical life	Inspect Cradle Terminals and replace, if required	
	Replace all Arc Chutes	
	Replace all Main Contacts	

Removal of ACB:

1. Trip the ACB. Isolate all remote voltage sources.

 Ensure that control circuit is de-energised.

2. Rack out the ACB to ISOLATED POSITION. Open the compartment door. Pull out the ACB to maintenance position page no. 33.
3. Position the ACB lifting truck in front of the ACB. Put the lifting sling around the ACB lifting lugs figure 32.
4. Remove the nuts anchoring the ACB to the telescopic rails and lift the ACB carefully by raising the lifting arm of the ACB lifting truck.
5. Push the rails inside and close the compartment door.
6. After removal, the ACB should be stored properly. Keep it covered with a polythene bag, free from dust.
7. While re-inserting the ACB, ensure that the ACB as well as all downstream feeder switches/isolators are open.



Figure 37 - ACB lifting truck

Removal of doors

1. Isolate the feeder.
2. In fixed type module disconnect all wires terminating at the equipment on the door.
3. Remove the bolts provided at the hinge figure 37 and slideout the door.

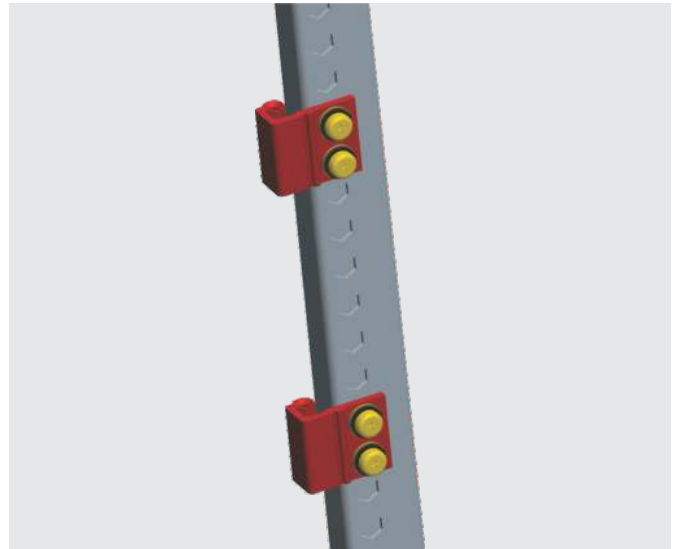

Figure 38 - Consealed hinge door



TROUBLE SHOOTING

On a live switchboard :

- Identify fault location using indicating lamps or monitoring system.
- Switch on control MCB / control fuse, ensure interlocks are active and turn on the feeder.
- Reset the relay or MCB after the fault has been cleared.
- If control MCB / control fuse trips verify the field terminations on the SIC.
- Check if breaker has been properly racked in to service position.
- If the control MCB has not tripped but the breaker still fails to operate, then check the health of the control circuit using a line tester.
- Check if respective MCBs are in 'ON' position.
- If the problem persists, check for component failure.
- Check for availability of supply at the control MCB connected to the auxiliary bus.
- After trouble-shooting ensure that the ACB is racked in to service position.
- If control fuse is used, check the health of the fuse. Replace if necessary.
- Periodical tightening of terminations as prescribed in commissioning manual of the ACB should be followed.
- Check the termination at shipping section terminals. (These are terminals for terminating wires running between panels)
- Check whether terminations from field connections are :
 1. Correctly terminated
 2. Tight
- Rack out the ACB to test position.

Periodical tightening of terminations as prescribed in commissioning manual of the ACB should be followed.

If the problem persist, contact your nearest sales office or email your query to AtYourService@Intebg.com

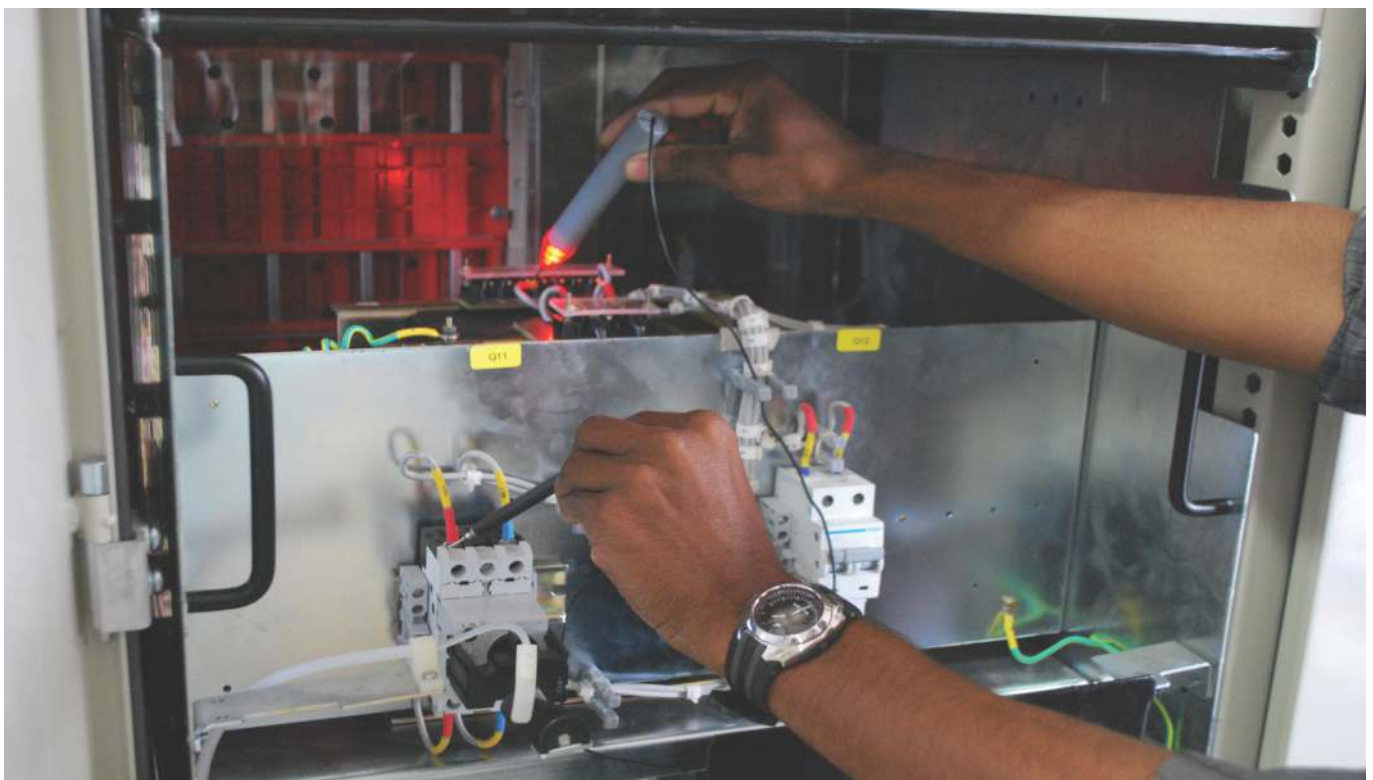

Problem	Probable Causes	Our Suggestion
ACB does not close on pressing "ON" button	<p>One or more arc-chute(s) not secured properly</p> <p>U / V release is present but not energized</p> <p>Mechanism spring is not charged. Indicator is in black background</p> <p>Trip Reset link is projecting out</p> <p>Racking Shutter is open</p> <p>"OFF" button is locked</p> <p>Mechanical Interlock disables closing</p>	<p>Press each arc chute firmly by hand</p> <p>Energize U / V release</p> <p>Charge the mechanism spring manually till a distinct sound is heard & indicator turns yellow</p> <p>Press trip reset link to reset position</p> <p>Close Racking Shutter (Insert Racking Handle once & pull back)</p> <p>Unlock "OFF" button</p> <p>Re - check before attempting to close the ACB</p>
Racking shutter does not re-close automatically after racking handle is pulled out	ACB is in-between Service / Test / Isolated position. Position Indicator is not aligned with any of the positions	Rack in or out the ACB to any of the distinct positions
ACB cannot be pushed in to Isolated position	ACB & Cradle ratings do not match	Put correct ACB
Racking Shutter does not open	<p>"OFF" button not kept pressed fully</p> <p>Door open / missing; hence Racking interlock is active</p> <p>Position lock(s) active</p>	<p>Keep OFF button pressed</p> <p>Close / provide door; else press Racking interlock lever (on extreme lower left side) manually</p> <p>Unlock</p>
ACB does not close electrically	Electrical antipumping is active	Interrupt 'Close' command once
Difficulty in racking the ACB in or out	ACB may not be properly mounted on telescopic rails	Withdraw ACB and check mounting.

1. Provide a small cabinet in every switchgear room to store.
 - Tools like screw drivers, fuse pulling handle, chassis racking handles.
 - All reference drawings like General Arrangement Drawing, Scheme drawing.
- Consumable spares like bulbs, fuses.
2. Do not use rewired HRC fuses. It may cause an explosion or arc, leading to a fire.

Problem	Probable Causes	Our Suggestion
Excessive pitting in the main contacts	Arcing contacts may not be fitted properly	Check adjustment of arcing contacts with filler gauge (>0.9 mm and <1 mm).
Overheating of main contacts	Arcing contacts may be touching each other	Check adjustment of arcing contacts with filler gauge (>0.9 mm and <1 mm).
Overheating of jaws and terminals	Terminals may be terminated loosely	Tighten terminations and terminals periodically
ACB trips soon after closing	The setting of overcurrent release or relay may be lower than the current drawn by feeder.	Check the setting of overcurrent release or relay

Figure 1	- PCC panel	03
Figure 2	- Door Open view	03
Figure 3	- Double Deck arrangement of busbars	10
Figure 4	- Busbar Support	10
Figure 5	- Four links support	10
Figure 6	- Two links support	10
Figure 7	- Auxbus Chamber	11
Figure 8	- Packing case Details	13
Figure 9	- Positioning of TU on truck	13
Figure 10	- Lifting angles	14
Figure 11	- Chain marks on packed TUs	14
Figure 12	- Typical arrangements	21
Figure 13	- Tools	22
Figure 14	- Panel Mounting on ISMC Base Channel / Base Frame	22
Figure 15	- Integral Base Frame	23
Figure 16	- ISMC Base Frame	23
Figure 17	- Top plate	24
Figure 18	- Busbar joining	24
Figure 19	- Tightning of Busbar joints	24
Figure 20	- Auxbus joining	25
Figure 21	- PCC - PCC Earthbar Coupling	26
Figure 22	- PCC - MCC Earthbar Coupling	26
Figure 23	- Top plate	27
Figure 24	- Power Cable terminals	27
Figure 25	- Power cable terminals	27
Figure 26	- Power cable terminals bottom cable entry	27
Figure 27	- Top Busduct termination	28
Figure 28	- Bottom Busduct termination	28
Figure 29	- Control Cable terminals	29
Figure 30	- Interpanel Wiring	29
Figure 31	- Unpacked ACB	30
Figure 32	- ACB lifting truck	30
Figure 33	- Installation of Control Transformer	32
Figure 34	- Extension of Panel	33
Figure 35	- Front facia of ACB	45
Figure 36	- Tightening of Busbar & Dropper Joint	48
Figure 37	- ACB lifting truck	50
Figure 38	- Consealed hinge door	50

LIST OF TABLES

Table 1	- Technical Data	04
Table 2	- Size of bolt Torque in m.kg	11
Table 3	- Size of bolt Torque	24

Services we offer:

Air Circuit Breaker Maintenance:

- Thorough cleaning of the ACB and its cradle
- Mechanical checks such as arcing contact gap, tightness check, greasing all moving parts
- Checks- Closing coil, trip coil and auxiliary contacts etc

Annual Maintenance Contracts (AMC):

- Electrical substation Maintenance (periodic maintenance of entire low voltage range of switchgear)
- Switchboard maintenance (periodic maintenance of Low voltage switchboard)

Switchboard Maintenance:

- Erection, Testing and Commissioning
- Commissioning assistance
- Total visual check
- Vacuum cleaning
- Tightness check for busbar joints and droppers
- Greasing of all moving parts
- IR (Insulation resistance) and high voltage test
- Maintenance workshop
- Retrofitting of the necessary products



L&T Electrical & Automation, Electrical Systems & Equipment - Head Office
Schneider Electric India Private Limited.
L&T Electrical & Automation, 7TH Floor, TC-2, Tower B, Prima Bay Gate No.5, Saki-Vihar Road,
Powai, Mumbai-400072, India.

The information contained herein is correct at the time of printing, but as products and manufacturing processes undergo continuous development, this information is subject to change without notice, and the company cannot be held liable for any alleged misinterpretation howsoever arising.

Sales Offices - India
Bengaluru, Chennai, Hyderabad,
Kolkata, Mumbai, New Delhi,
Vadodara

Sales Offices - International
India, Kuwait, Oman, Qatar, UAE